

www.astromedinst.com

ASTRO MEDICAL INSTRUMENTS

Dental Instruments Catalogue



ASTRO
MEDICAL INSTRUMENTS

Defence Road, Near Jawad Center, Sialkot 51310, Pakistan.

Tel : 0092 52 4000230, 3561797, 3252487 / Fax :0092 52 - 3560884

E-mail :info@astromedinst.com / Sales@astromedinst.com

Web :www.astromedinst.com

Respected Customers,

ASTRO Medical Instruments: proudly present you the revised edition of our E-Catalogue. This is the fruit of our dedicated research and endeavour to stay updated and convenient for our customers. We have tried our best to achieve perfection and we strongly hope that this revised catalogue would sufficiently meet all customer needs.

ASTRO Medical Instruments is one of the leading Manufacturers and Exporters of Surgical Instruments. We have gained the maximum expertise under the shadow of our ancestors, and have equipped ourselves with the latest technologies and progressive innovations. We ensure our customers, their satisfaction at their own conditions, their desired customizations and specifications. The adoption of sophisticated methodology, use of most modern machines, and high quality raw material are the key factors which have led us to success.

Our unit is strict in Quality checking and our company is ISO 9001:2008 and CE certified, which ensures you that you would definitely get the best of the quality on the best prices. Infact its our brilliance that we perfectly keep an appreciably perfect balance between the best quality and the most competitive prices.

Kindly review our latest edition of E-Catalogue and we'll welcome any sample or price inquiry from our worthy customers or customers to-be.

C.E.O.

CERTIFICATIONS

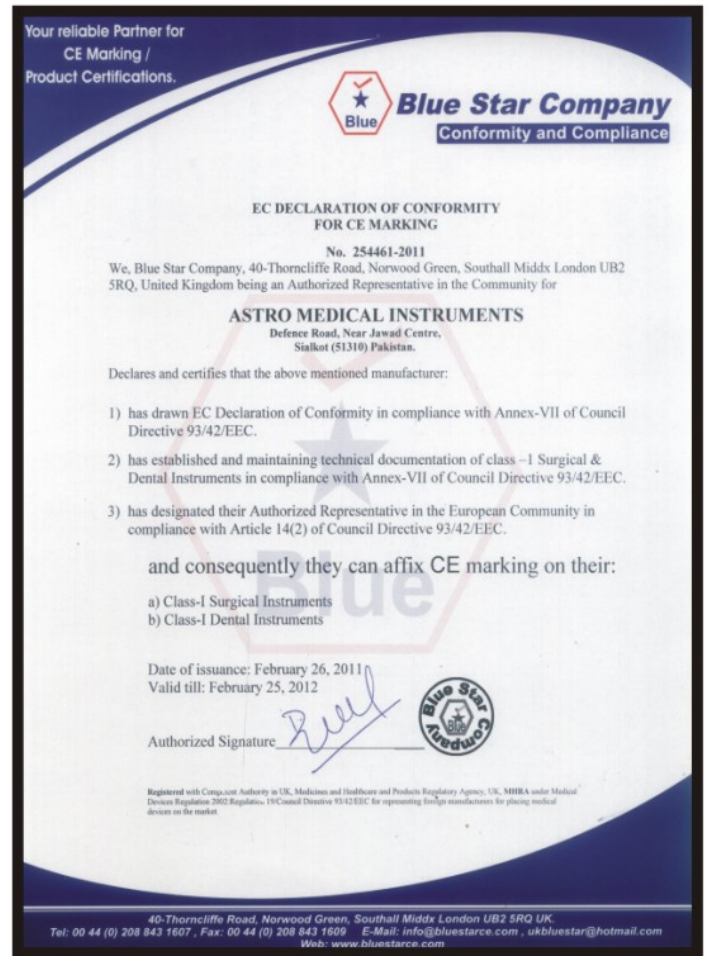

ASTRO MEDICAL INSTRUMENTS



RESEARCH & DEVELOPMENT

Reserch Innovation & Product Development

Reserch Innovation & Product Development is one of the most important on-going processes in our company. We manufacture in a highly controlled environment and use most modern methods by the highly qualified professionals. We have technical collaboration with German and Italian manufacturers of surgical and medical instruments.

ASTRO Medical Instruments

“THE NAME YOU CAN TRUST FOR UNMATCHED QUALITY”

- 1) Instruments should be rinsed immediately after use. to removed blood serum and salines or other residues
- 2) Do not use a sponge basin as residue from normal saline can result in corrosion development over time.
- 3) Instruments should be carefully dried after cleaning as moister can cause corrosion to develop over time.
- 4) Instruments should NOT be left in cold sterilization solutions for prolonged periods, as this is likely to cause corrosion After cold sterilization instruments should be rinsed in distilled or demineralized water and carefully dried, before storage.
- 5) When using cold sterilization solutions for sterilization the solution should be changed sd directed .Extensive use of the solution will cause the solution to become corrosive and subsequently , damage the instruments.
- 6) Always use suitable cleaning materials to clean instruments
- 7) Do not use steel wool scoring powder or high PH detergents to clean instruments. When cleaning by hand always use a specified instruments cleaner or a neutral detergent soap solution and a soft brush and rinse with detailed or demineralized water.
- 8)Always check your autoclave. Copper, Magnesium, Calcium, Sodium or Iron in water can result in spotting, staining and corrosion. Always clean the lime deposits from steam lines, periodically or use distilled or demineralized water for your autoclave. If possible, install a steam filter, which will reduce the amount of dust rust and scaling.
- 9) Always ensure the muslin wraps are rinsed adequately (at least 7 to 8 times) whilst washing for removal of chlorine and blood.
- 10) Instruments must not be left in the under mentioned solution for prolonged, as this may cause corrosion on the instruments.
 - A) Stannous Chloride, Ferrous, Calcium, Barium or Aluminum Solutions.
 - B) Lodine, Lysol or phenol
 - C) Zephirin or Dakins Slution
 - D) Any Potassium, Mercury or acid solution
- 11) Avoid sterilizing stainless instruments with chrome plated instruments, as the surface of chrome plate allows on electrolic action to accur between unlike metals, causing pitying and/or a rusty opearance.
- 12) To prevent an excessive amount of condensation forming on the surface of the instruments, preheat instruments in autoclave before allowing steam to enter.
- 12) Do not open the autoclave immediately after sterilization cycle is complete, as excessive condensation will develop on the surface of the instruments. Crack the clave to allow drying before completely opening the outoclave.

Root Elevators Set, Extraction Set ●●●



Set - 01

KIT ROOT ELEVATORS
(Complete Set of 6 Pcs.)

- 01 ROOT ELEVATORS APICAL Fig.301
- 02 ROOT ELEVATORS APICAL Fig.302
- 03 ROOT ELEVATORS APICAL Fig.303
- 04 ROOT ELEVATORS SELDIN Fig.34S
- 05 ROOT ELEVATORS CRYER Fig.44
- 06 ROOT ELEVATORS CRYER Fig.45



Set - 02

EXTRACTION AND ORAL SURGERY
(Complete Set of 9Pcs.)

- 01 EXTRACTING FORCEPS Fig. 67A
- 02 EXTRACTING FORCEPS Fig. 51A
- 03 EXTRACTING FORCEPS Fig. 33
- 04 EXTRACTING FORCEPS Fig. 79
- 05 ROOT ELEVATORS FLOHR Fig. 20
- 06 ROOT ELEVATORS FLOHR Fig. 238
- 07 ROOT ELEVATORS FLOHR Fig. 239
- 08 MAYO HEGAR NEEDLE HOLDER 16 cm
- 09 MATHIEU NEEDLE HOLDER 14 cm





●●● Extraction Set

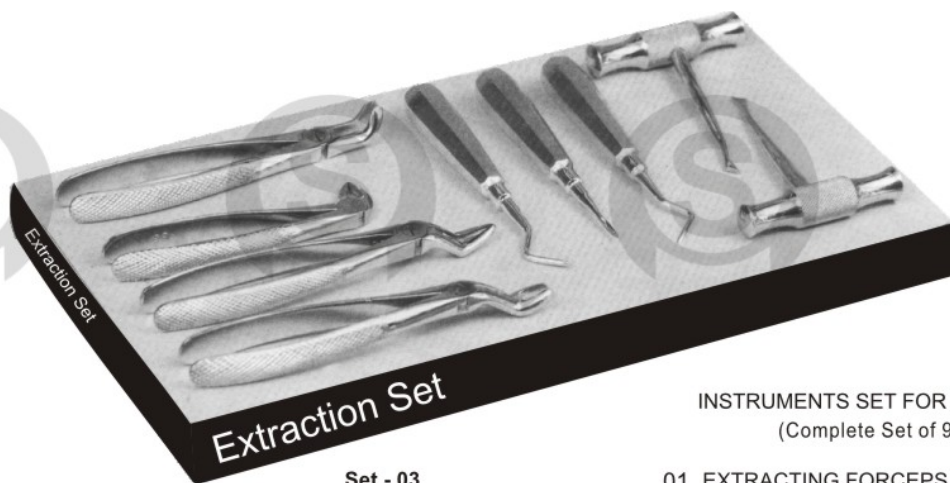

Set - 03



INSTRUMENTS SET FOR EXTRACTION
(Complete Set of 9 Pcs.)

- | | | |
|----|-----------------------|----------|
| 01 | EXTRACTING FORCEPS | Fig. 67A |
| 02 | EXTRACTING FORCEPS | Fig. 51A |
| 03 | EXTRACTING FORCEPS | Fig. 33 |
| 04 | EXTRACTING FORCEPS | Fig. 79 |
| 05 | ROOT ELEVATORS FLOHR | Fig. 20 |
| 06 | ROOT ELEVATORS FLOHR | Fig. 238 |
| 07 | ROOT ELEVATORS FLOHR | Fig. 239 |
| 08 | ROOT ELEVATORS WINTER | Fig. 320 |
| 09 | ROOT ELEVATORS WINTER | Fig. 321 |



Set - 04



INSTRUMENTS SET FOR EXTRACTION
(Complete Set of 8 Pcs.)

- | | | |
|----|--------------------|----------|
| 01 | EXTRACTING FORCEPS | Fig. 1 |
| 02 | EXTRACTING FORCEPS | Fig. 17 |
| 03 | EXTRACTING FORCEPS | Fig. 18 |
| 04 | EXTRACTING FORCEPS | Fig. 79 |
| 05 | EXTRACTING FORCEPS | Fig. 67A |
| 06 | EXTRACTING FORCEPS | Fig. 51A |
| 07 | EXTRACTING FORCEPS | Fig. 13 |
| 08 | EXTRACTING FORCEPS | Fig. 22 |



Set - 05

INSTRUMENTS SET FOR EXTRACTION
(Complete Set of 8 Pcs.)

- 01 EXTRACTING FORCEPS Fig. 1
- 02 EXTRACTING FORCEPS Fig. 17
- 03 EXTRACTING FORCEPS Fig. 18
- 04 EXTRACTING FORCEPS Fig. 79
- 05 EXTRACTING FORCEPS Fig. 67A
- 06 EXTRACTING FORCEPS Fig. 51A
- 07 EXTRACTING FORCEPS Fig. 13
- 08 EXTRACTING FORCEPS Fig. 22



Set - 06

EXTRACTION FORCEPS FOR CHILDREN
(Complete Set of 10 Pcs.)

- 01 EXTRACTING FORCEPS FINO Fig. 37
- 02 EXTRACTING FORCEPS FINO Fig. 39
- 03 EXTRACTING FORCEPS FINO Fig. 39L
- 04 EXTRACTING FORCEPS FINO Fig. 39R
- 05 EXTRACTING FORCEPS FINO Fig. 51S
- 06 EXTRACTING FORCEPS FINO Fig. 13S
- 07 EXTRACTING FORCEPS FINO Fig. 30S
- 08 EXTRACTING FORCEPS FINO Fig. 33S
- 09 EXTRACTING FORCEPS FINO Fig. 22S
- 10 EXTRACTING FORCEPS FINO Fig. 38





●●● Extraction Set

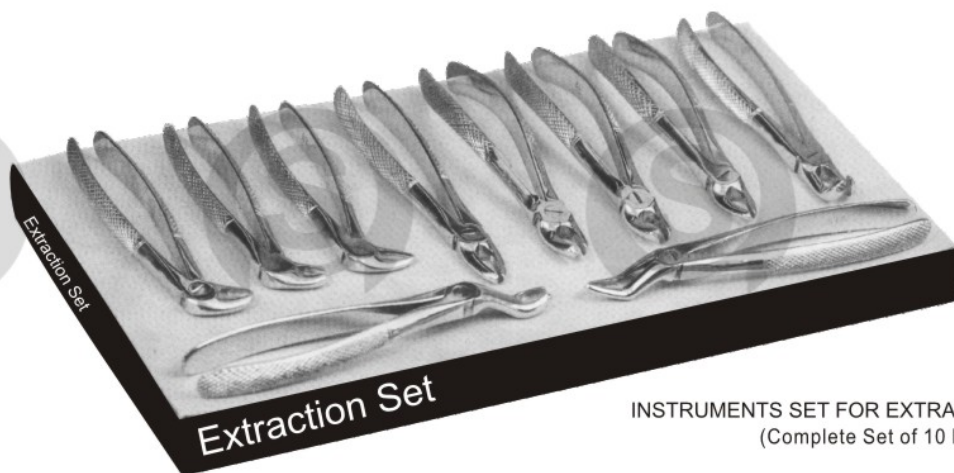

Set - 07

INSTRUMENTS SET FOR EXTRACTING FORCEPS
(Complete Set of 10 Pcs.)

- | | | |
|----|--------------------|----------|
| 01 | EXTRACTING FORCEPS | Fig. 2 |
| 02 | EXTRACTING FORCEPS | Fig. 7 |
| 03 | EXTRACTING FORCEPS | Fig. 51A |
| 04 | EXTRACTING FORCEPS | Fig. 17 |
| 05 | EXTRACTING FORCEPS | Fig. 18 |
| 06 | EXTRACTING FORCEPS | Fig. 67A |
| 07 | EXTRACTING FORCEPS | Fig. 13 |
| 08 | EXTRACTING FORCEPS | Fig. 33 |
| 09 | EXTRACTING FORCEPS | Fig. 22 |
| 10 | EXTRACTING FORCEPS | Fig. 79 |



Set - 08

EXTRACTING FORCEPS SET FOR CHILDREN KLEIN PATTERN
(Complete Set of 7 Pcs.)

- | | | |
|----|-----------------------------|----------|
| 01 | EXTRACTING FORCEPS CHILDREN | Fig. 5 |
| 02 | EXTRACTING FORCEPS CHILDREN | Fig. 6 |
| 03 | EXTRACTING FORCEPS CHILDREN | Fig. 7 |
| 04 | EXTRACTING FORCEPS CHILDREN | Fig. 137 |
| 05 | EXTRACTING FORCEPS CHILDREN | Fig. 139 |
| 06 | EXTRACTING FORCEPS CHILDREN | Fig. 3 |
| 07 | EXTRACTING FORCEPS CHILDREN | Fig. 51S |



EXTRACTING FORCEPS ENGLISH PATTERN ●●●



201-0001
Fig.1
Upper centrals
& canines

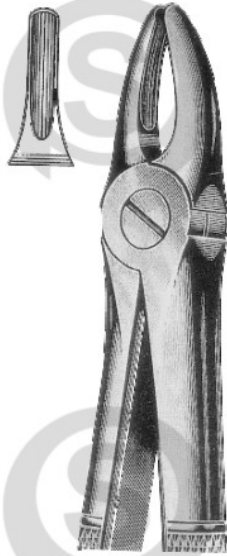

201-0002
Fig.2
Upper laterals
& bicuspids
& bicuspid



201-0003
Fig.3
Upper incisors
& canines

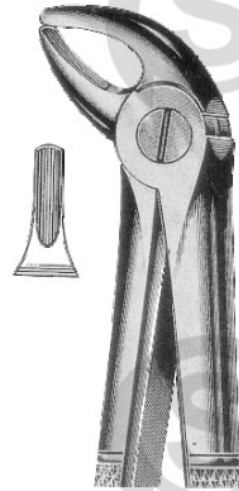

201-0004
Fig.4
Lower incisors
& canines

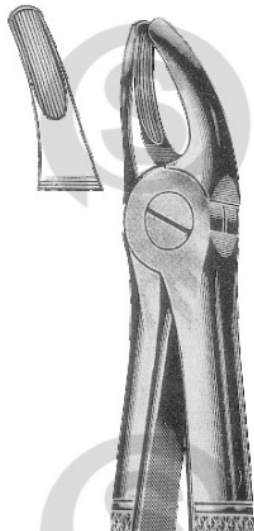

201-0005
Fig.7
Upper primolars

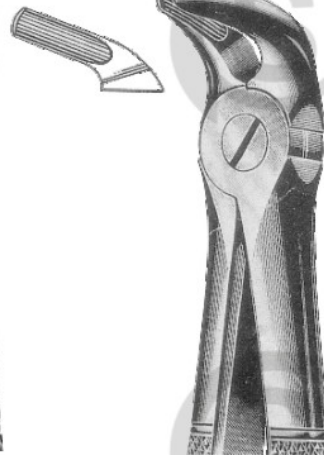

201-0006
Fig.8
Lower primolars

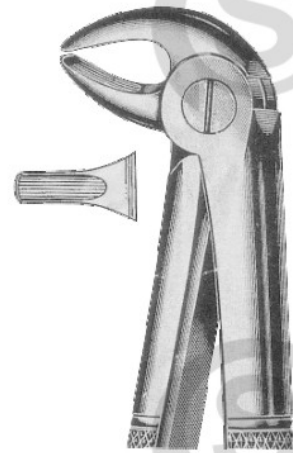

201-0007
Fig.13
Lower primolars



●●● **EXTRACTING FORCEPS** ENGLISH PATTERN



201-0008
Fig.17
Right upper molars

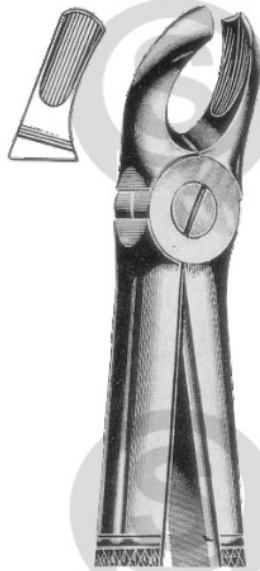

201-0009
Fig.18
Left upper molars

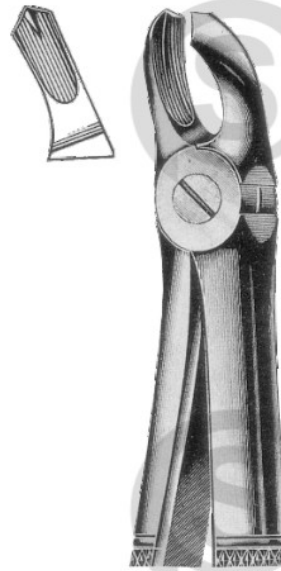

201-0010
Fig.18A
Upper molars

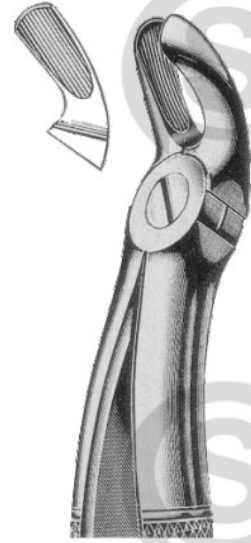

201-0011
Fig.18A
Upper wisdoms

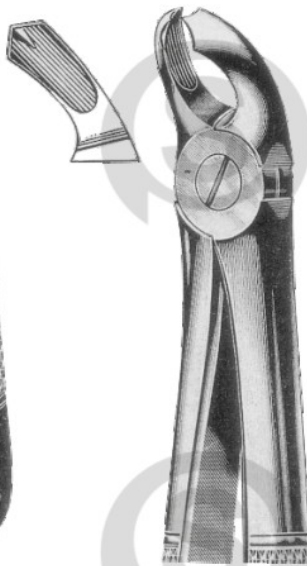

201-0012
Fig.20
Lower wisdoms

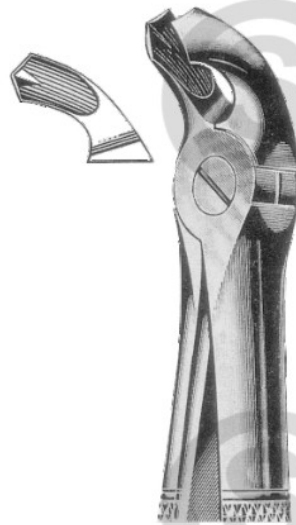

201-0013
Fig.21
Lower molar

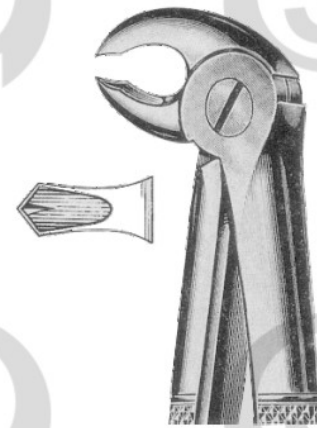

201-0014
Fig.22
Lower molars
Hawk's bills

ASTRO MEDICAL INSTRUMENTS

EXTRACTING FORCEPS ENGLISH PATTERN ●●●

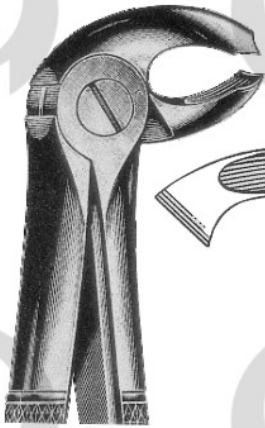

201-0015
Fig.23
Right lower molars



201-0016
Fig.24
Left lower molars

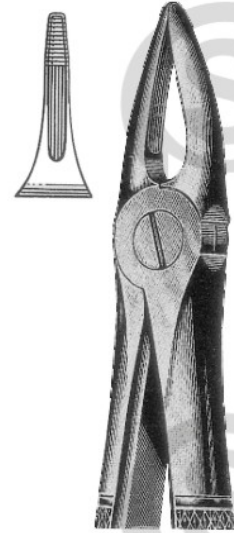

201-0017
Fig.29
Upper root & incisors

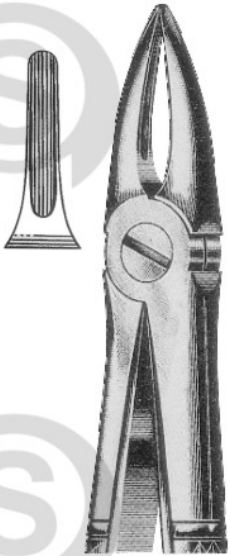

201-0018
Fig.29N
Roots of upper incisors

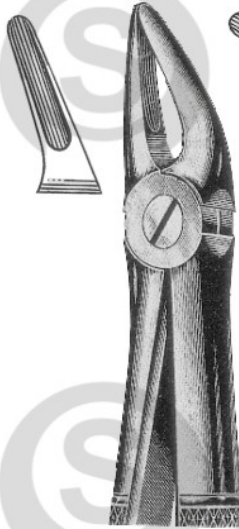

201-0019
Fig.30
Upper roots & incisors

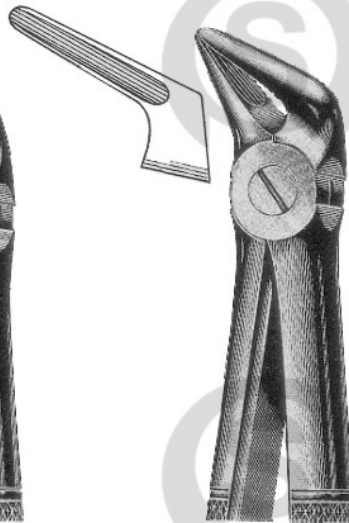

201-0020
Fig.31
Lower roots

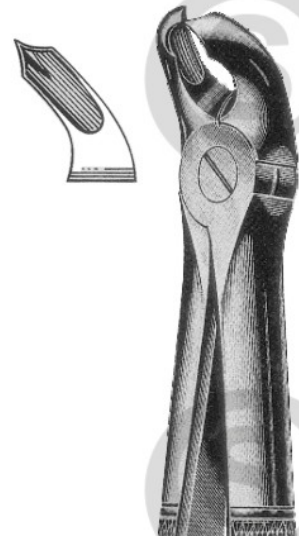

201-0021
Fig.32
Lower molars



●●● **EXTRACTING FORCEPS** ENGLISH PATTERN

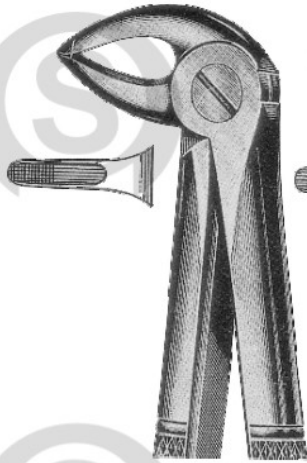

201-0022
Fig.33
Lower roots

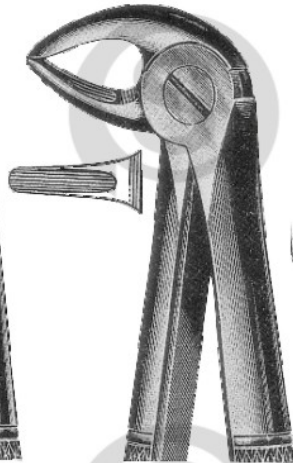

201-0023
Fig.33A
Lower roots

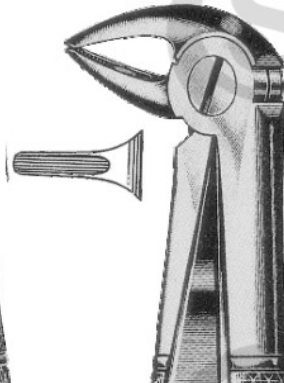

201-0024
Fig.33C
Lower roots

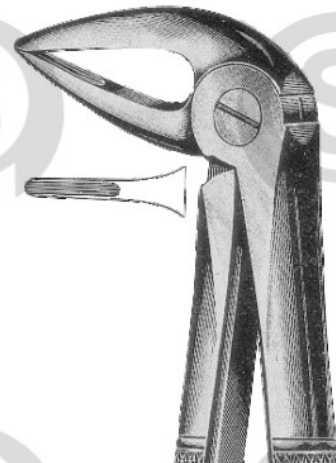

201-0025
Fig.33M
Lower roots with long beak

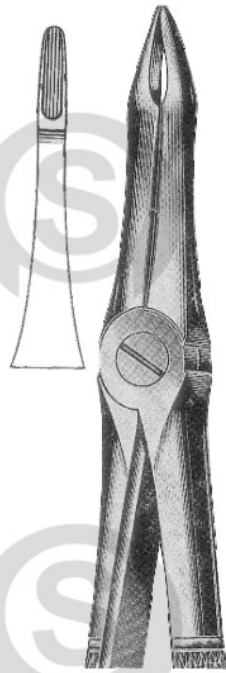

201-0026
Fig.41
Upper roots

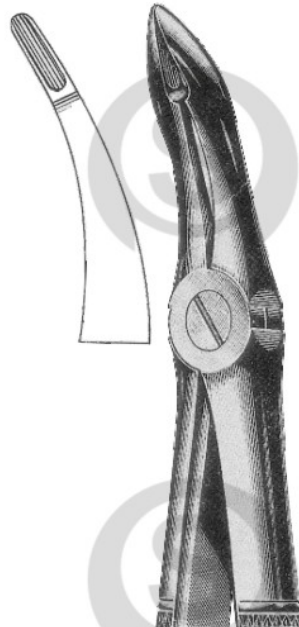

201-0027
Fig.44
Upper roots

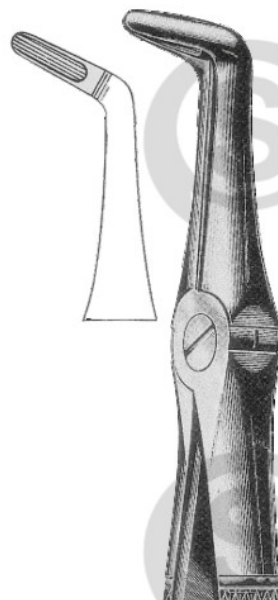

201-0028
Fig.45
Lower roots

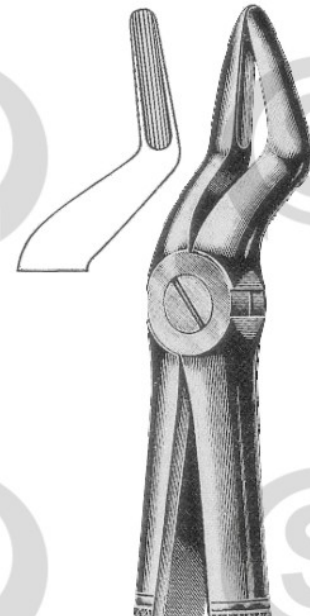

201-0029
Fig.51
Upper roots

EXTRACTING FORCEPS ENGLISH PATTERN ●●●

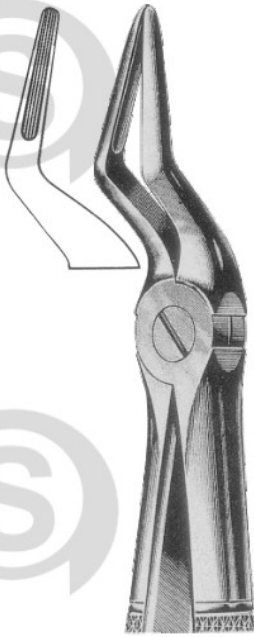

201-0030
Fig.51A
Upper roots narrow beak

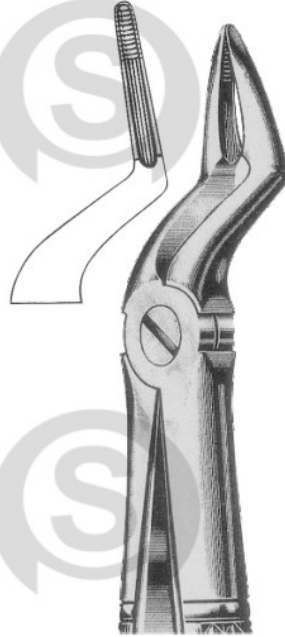

201-0031
Fig.51C
Upper roots

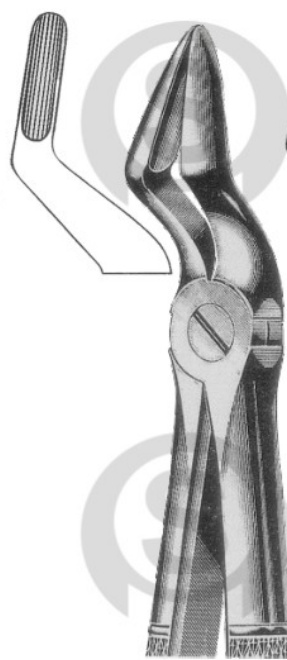

201-0032
Fig.52
Upper roots & canines
with wider beak

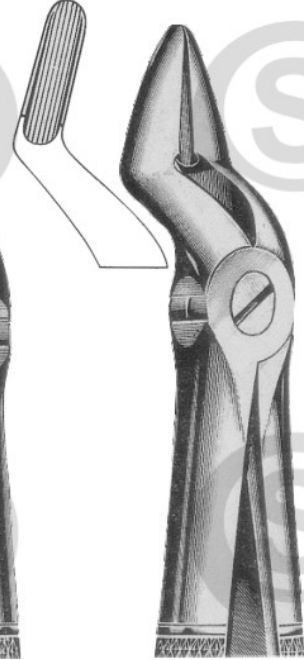

201-0033
Fig.52A
Upper teeth & resection

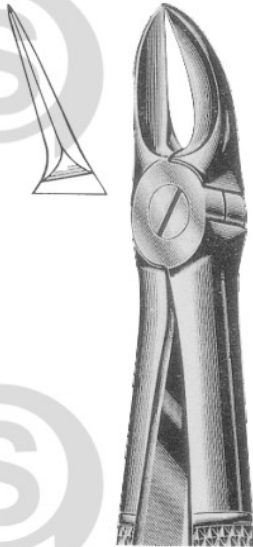

201-0034
Fig.55
Separating upper molars roots

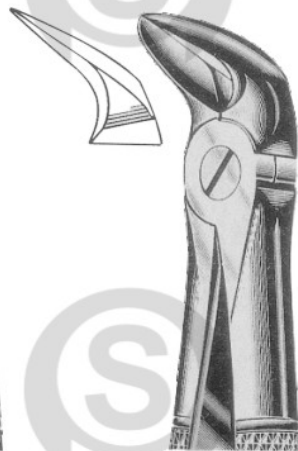

201-0035
Fig.56
Separating lower molars roots



201-0036
Fig.67
Upper wisdoms

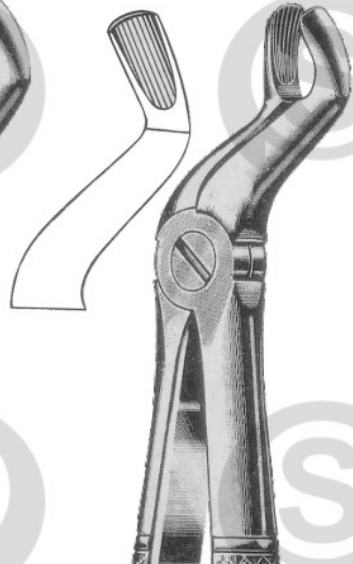

201-0037
Fig.67A
Upper wisdoms



●●● **EXTRACTING FORCEPS** ENGLISH PATTERN

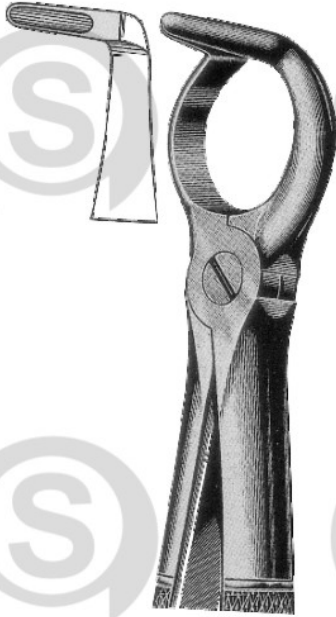

201-0038
Fig.68
Lower roots

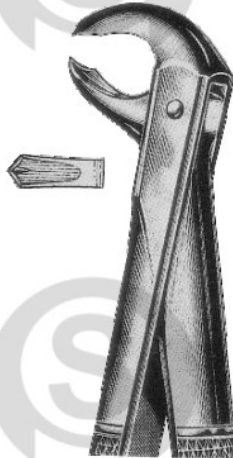

201-0039
Fig.73
Lower molars (hawk's bill)

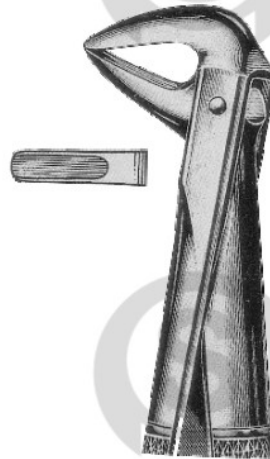

201-0040
Fig.74
Lower incisors & roots



201-0041
Fig.74M
Lower incisors & roots



201-0042
Fig.74N
Lower incisors & roots

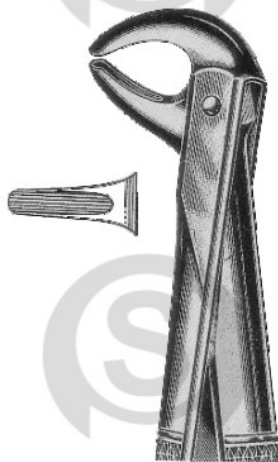

201-0043
Fig.75
Lower premolars & canines

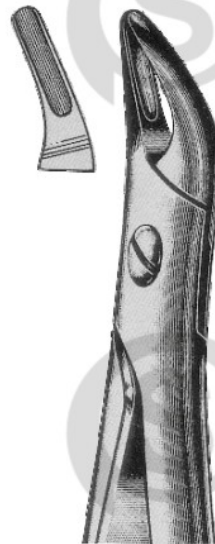

201-0044
Fig.76
Upper roots

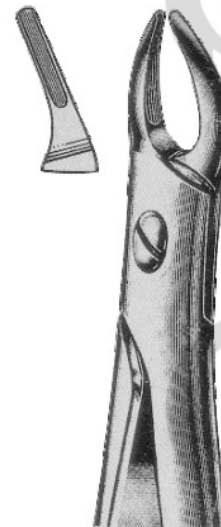

201-0045
Fig.76N
Upper roots
Narrow break

EXTRACTING FORCEPS ENGLISH PATTERN ●●●



201-0046
Fig.79
Lower wisdoms



201-0047
Fig.79A
Lower wisdoms

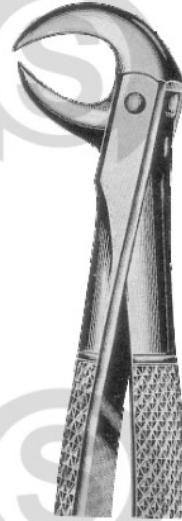

201-0048
Fig.86A
Lower molars



201-0049
Fig. 86B
Lower molars



201-0050
Fig.86C
Lower molars

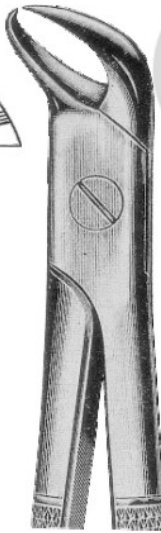
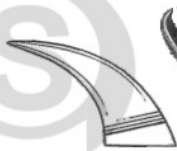

201-0051
Fig.87
Cowhorn beak

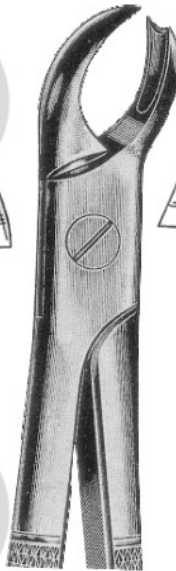

201-0052
Fig.89
Right upper molars



201-0053
Fig.9
Left upper molars



●●● **EXTRACTING FORCEPS** ENGLISH PATTERN

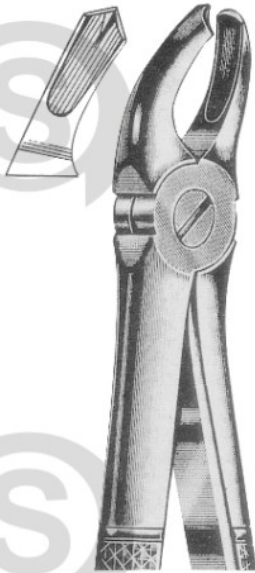

201-0054
Fig.94
Right upper molars

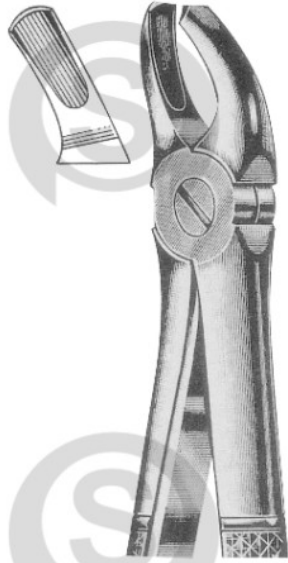

201-0055
Fig.95
Left upper molars

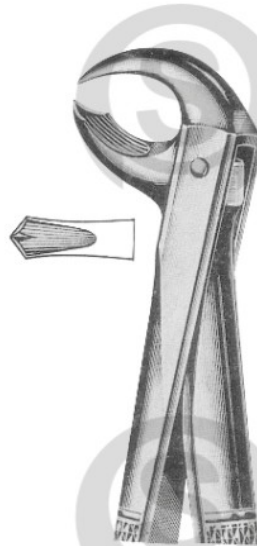

201-0056
Fig.99
Lower molars
(broken-down)



201-0057
Fig.99 1/4
Lower molars
(broken-down)

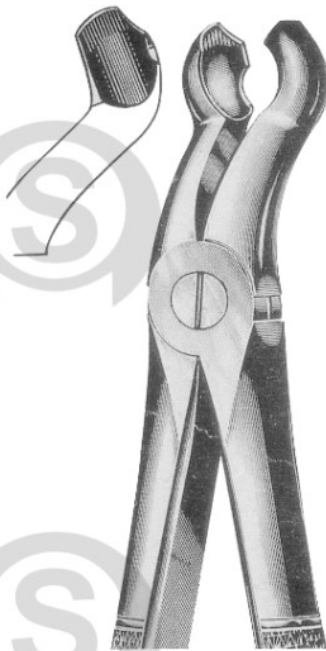

201-0058
Fig.121
Upper wisdoms

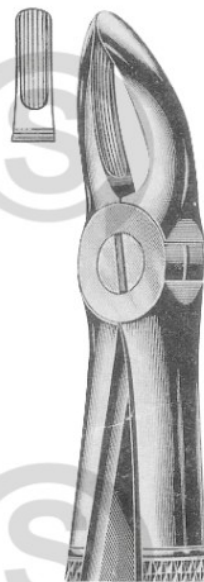

201-0059
Fig.136
Upper centrals
& roots

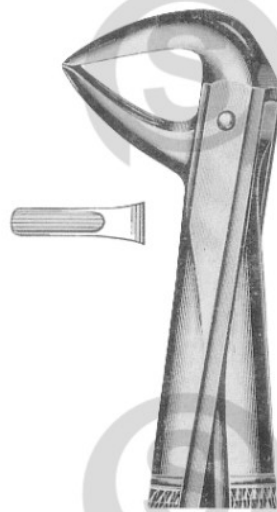

201-0060
Fig.137
Lower centrals
& roots

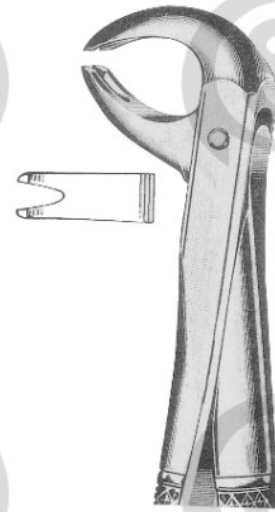

201-0061
Fig.167
Universal pincer
for lower teeth
molars & premolars

ASTRO MEDICAL INSTRUMENTS

EXTRACTING FORCEPS ENGLISH PATTERN ●●●

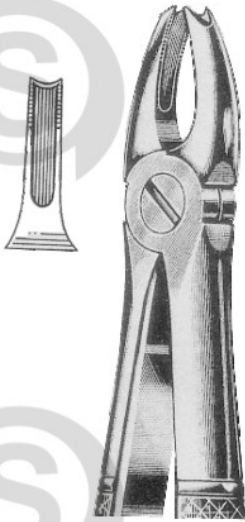

201-0062
Fig.168
Upper canines

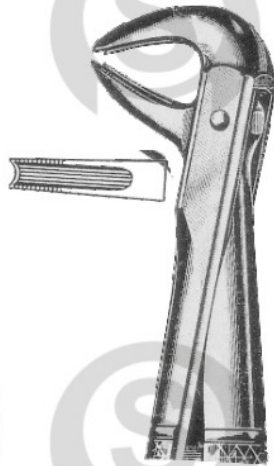

201-0063
Fig.169
Lower canines & premolars

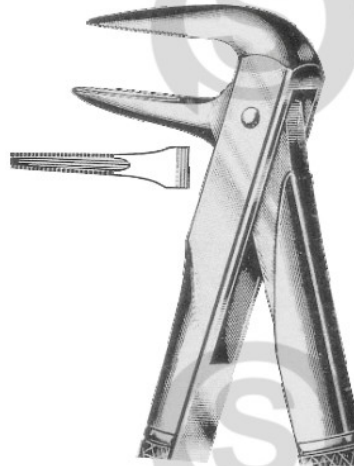

201-0064
Fig.233
Lower roots (parallel beaks)

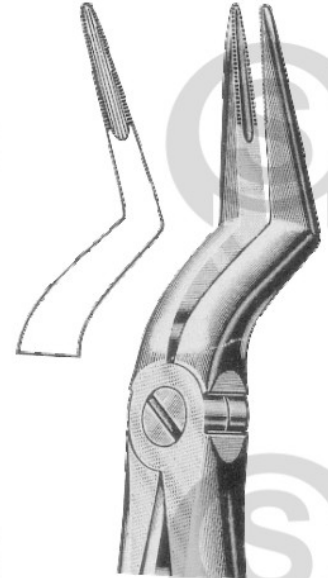

201-0065
Fig.235
Lower roots (parallel beaks)

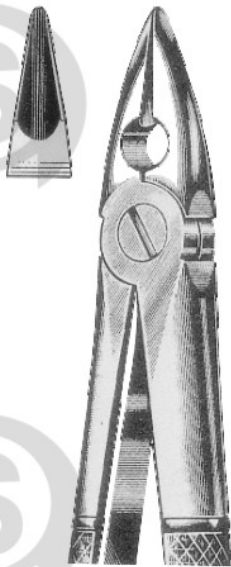

201-0066
Fig.MD 1
Universal Forceps for upper
wisdoms, premolars & roots

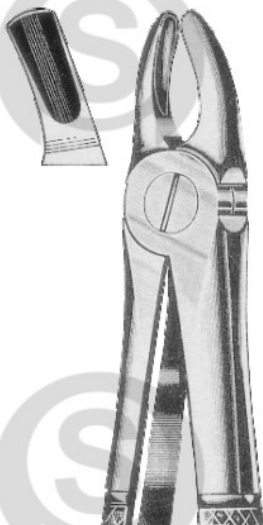

201-0067
Fig.MD 2
Upper molars

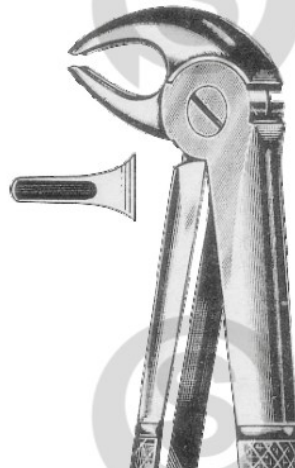

201-0068
Fig.MD 3
Lower incisors, premolars & roots

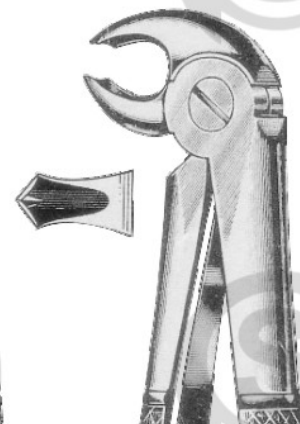

201-0069
Fig.MD 4
Lower molars



●●● **EXTRACTING FORCEPS** ENGLISH PATTERN

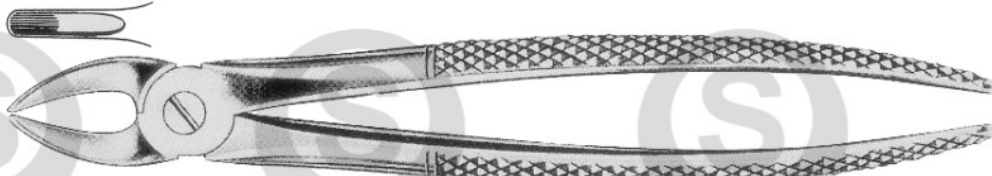

201-0070
Fig.37

Children's upper incisors & canines

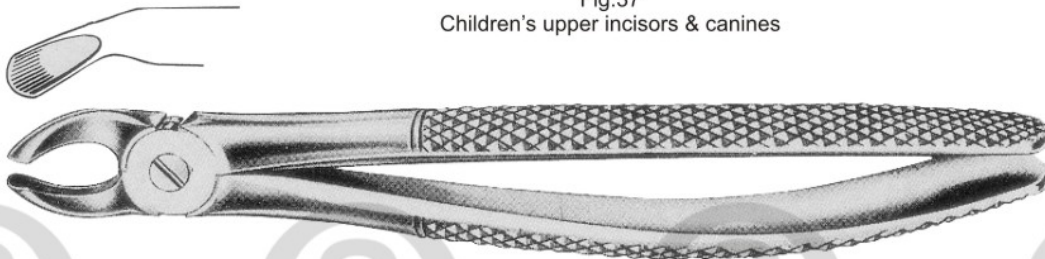

201-0071
Fig.39

Children's upper molars & universal

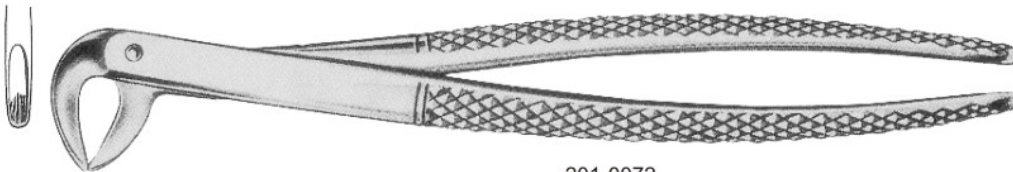

201-0072
Fig.123

Children's lower teeth universal

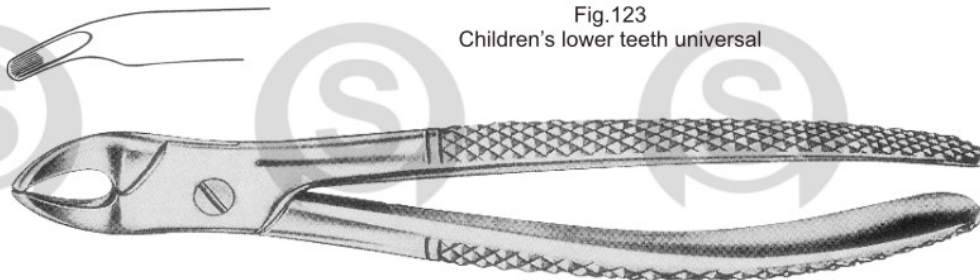

201-0073
Fig.138

Children's upper universal & roots

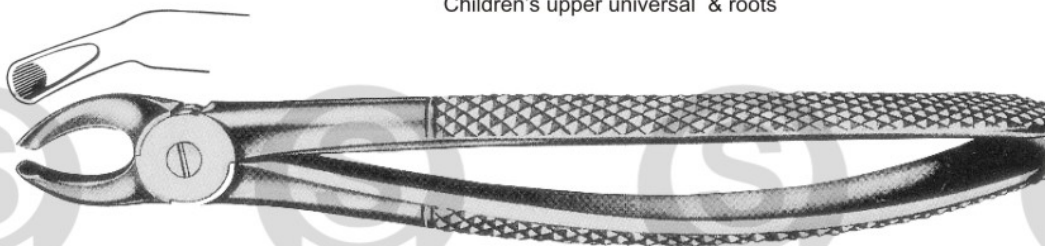

201-0074
Fig.157

Children's upper molars universal

EXTRACTING FORCEPS CHILDREN'S PATTERN ●●●

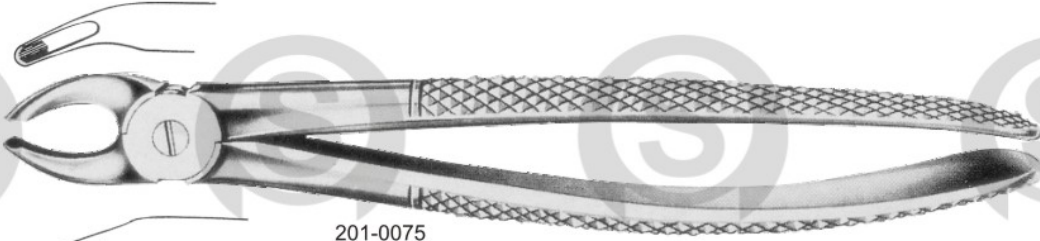

201-0075
Fig.158

Children's upper teeth molars universal

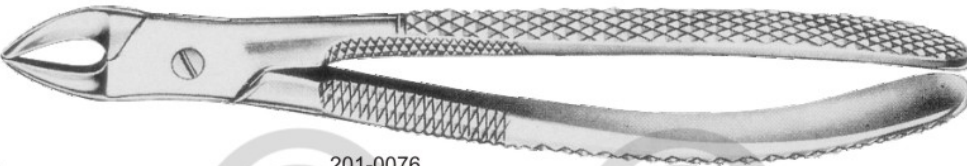

201-0076
Fig.159

Children's lower molars universal

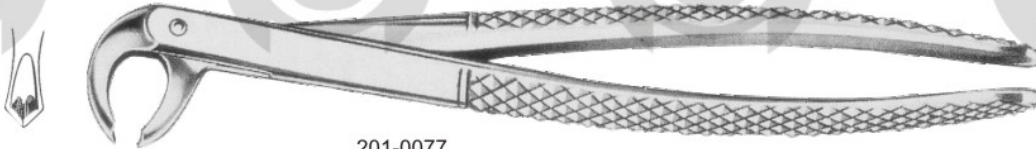

201-0077
Fig.160

Children's upper lower universal (hawk's bill)

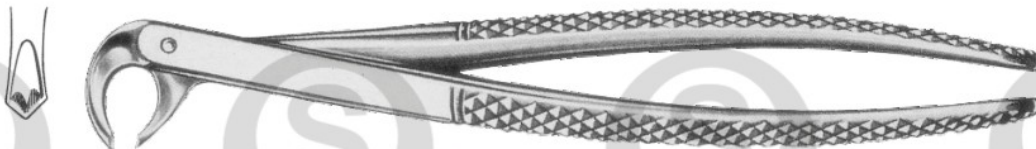

201-0078
Fig.161

Children's lower & roots

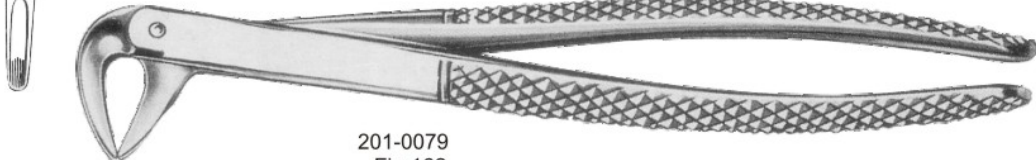

201-0079
Fig.162

Children's upper centrals

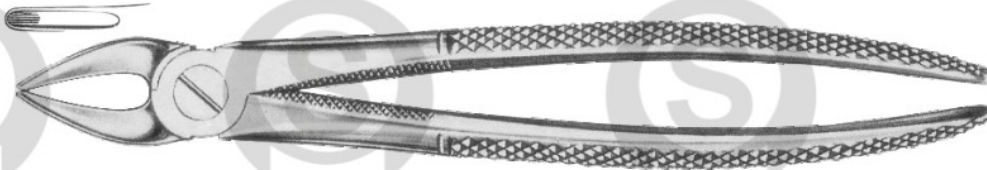

201-0080
Fig.163

Children's upper centrals



●●● **EXTRACTING FORCEPS** FOR CHILDREN'S WITH SPRING

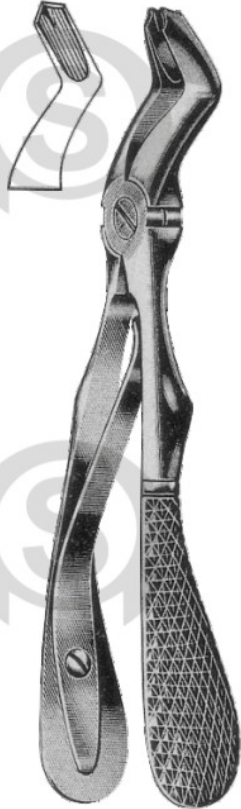

201-0081
Fig. 3
Upper molars

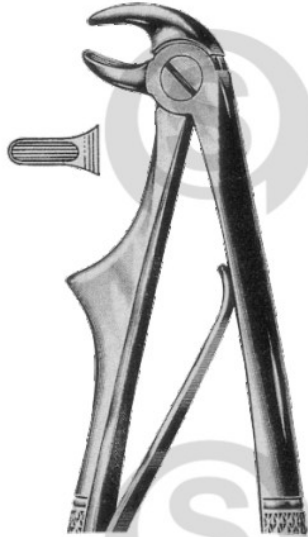

201-0082
Fig. 5
Lower incisors

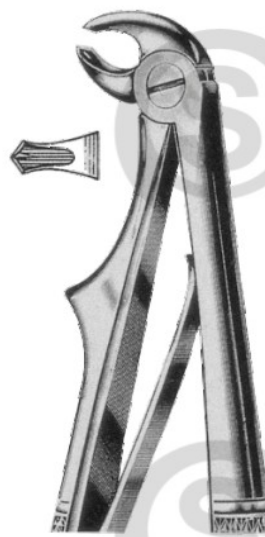

201-0083
Fig. 6
Lower molars

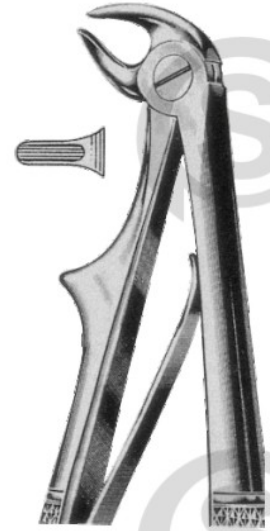

201-0084
Fig. 7
Lower roots



201-0085
Fig. 137
Upper incisors
& canines



201-0086
Fig. 139
Upper premolars

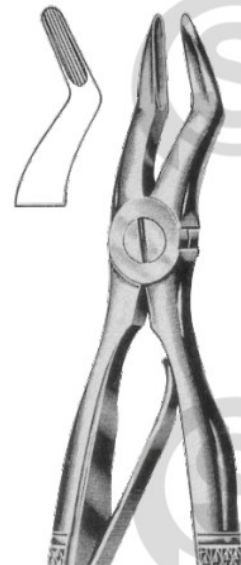

201-0087
Fig. 51S
Upper roots

EXTRACTING FORCEPS ROOT FRAGMENT FORCEPS ●●●



201-0088
Universal pattern for upper teeth



201-0089
Universal pattern for lower teeth



201-0090
Fig. 22 1/2L
Left lower wisdoms & molars

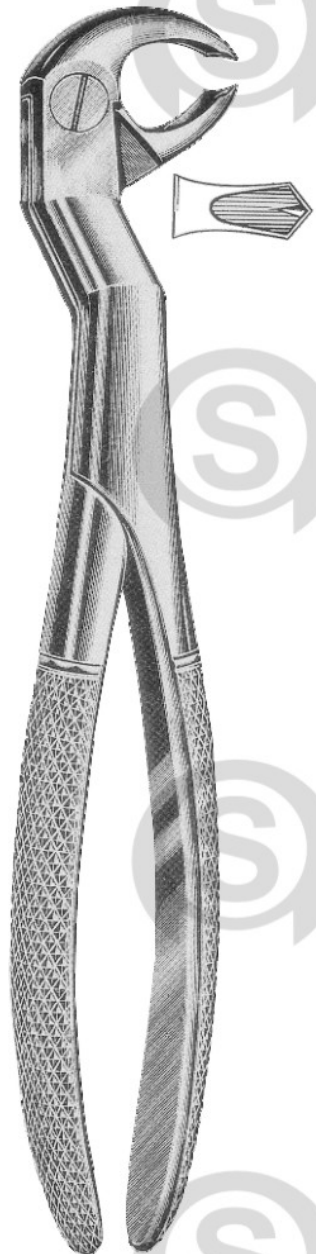

201-0091
Fig. 22 1/2R
Right lower wisdoms & molars



●●● **EXTRACTING FORCEPS** AMERICAN PATTERN



201-0092
Fig. 1
Upper centrals, laterals & cuspids



201-0093
Fig. 5
Lower third molars

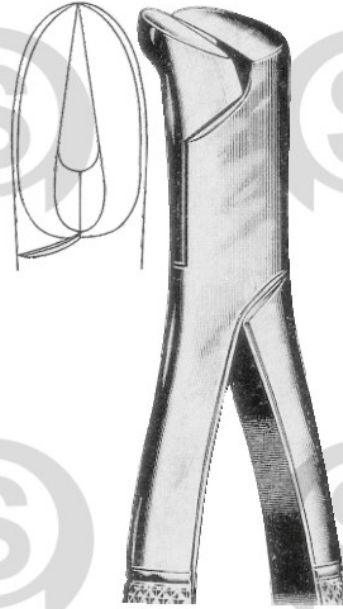

201-0094
Fig. 6
Splitting forceps



201-0095
Fig. 10 H
Upper molars hook-handle



201-0096
Fig. 10 S
Upper molars straight-handle



201-0097
Fig. 15
Lower molars

ASTRO MEDICAL INSTRUMENTS

EXTRACTING FORCEPS AMERICAN PATTERN ●●●



201-0098
Fig. 16 S
Lower molars children's



201-0099
Fig. 16
Lower molars (cow-horn beak)
201-0100
Fig.16 SK

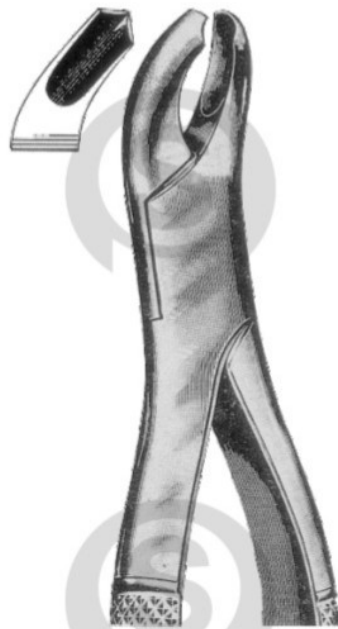

201-0105
Fig. 18R
Upper molars right side
201-0106
Fig.18R SK



201-0101
Fig. 17
Lower molars
201-0102
Fig.17 SK



201-0103
Fig. 18L
Upper molars left side
201-0104
Fig.18L SK

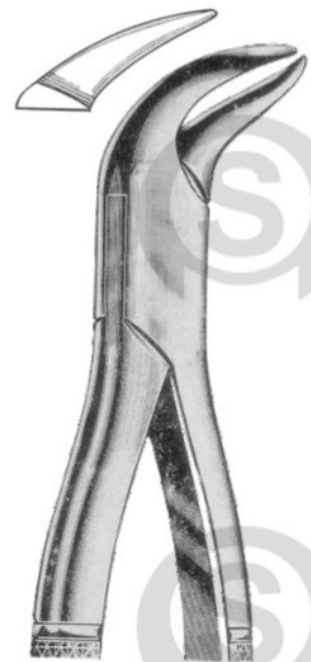

201-0107
Fig. 23
Lower molars (cow-horn beak)
201-0108
Fig.23 SK



EXTRACTING FORCEPS AMERICAN PATTERN

ASTRO MEDICAL INSTRUMENTS



201-0109
Fig. 32
Upper molars & pre molars
strong beak
201-0110
Fig. 32 SK



201-0111
Fig. 53 L
Upper molars left side
201-0112
Fig. 53 L SK



201-0113
Fig. 53 R
Upper molars right side
201-0114
Fig. 53R SK



201-0115
Fig. 62
Universal forceps
for upper teeth & roots
201-0116
Fig. 62 SK



201-0117
Fig. 65
Upper Incisors & root
201-0118
Fig. 65 SK

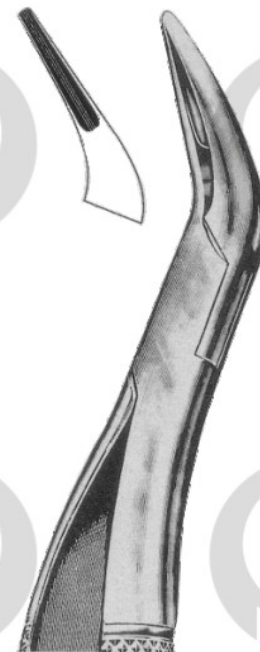

201-0119
Fig. 69
Fragments & small roots
Upper & lower
201-0120
Fig. 69 SK

EXTRACTING FORCEPS AMERICAN PATTERN ●●●

AMERICAN PATTERN



201-0121
Fig. 88 R
Right upper molars
201-0122
Fig. 88 R SK



201-0123
Fig. 88L
Left upper molars
201-0124
Fig. 88L SK

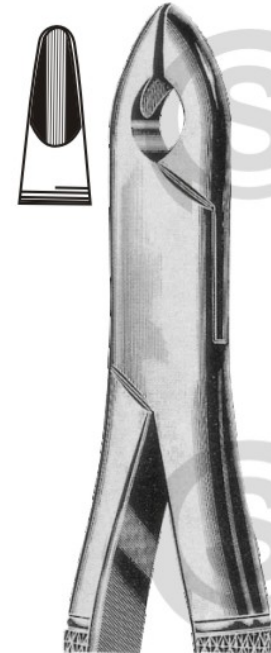

201-0125
Fig. 99C
Upper Premolars,
Molar & incisors
201-0126
Fig. 99C SK

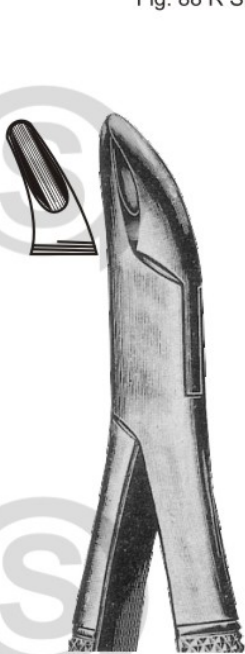

201-0127
Fig. 101
Universal forceps
for premolars
201-0128
Fig. 101 SK

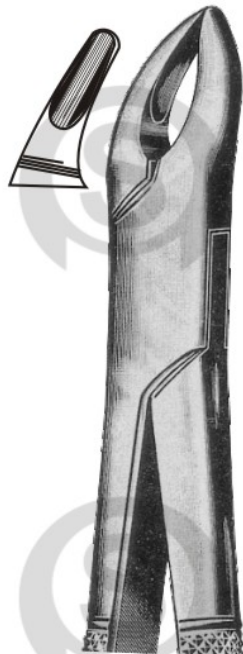

201-0129
Fig. 150
Upper premolars,
incisors & roots
201-0130
Fig. 150 SK

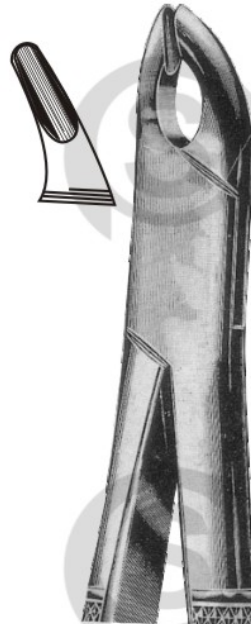

201-0131
Fig. 150A
Upper premolars
incisors & roots
201-0132
Fig. 150A SK



201-0133
Fig. 150S
Upper premolars
incisors & roots
for children
201-0134
Fig. 150 SK



●●● **EXTRACTING FORCEPS** AMERICAN PATTERN

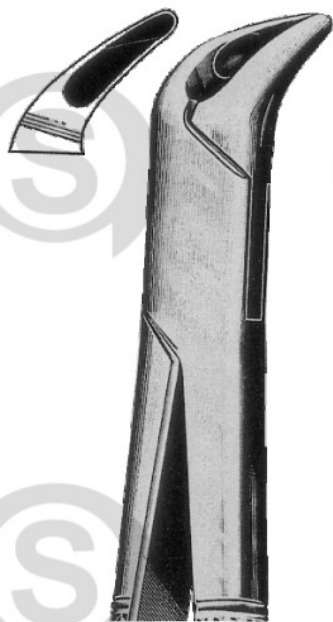

201-0135
Fig. 151
Lower premolars, incisors & roots
201-0136
Fig. 151 SK



201-0137
Fig. 151A
Lower premolars, incisors & roots
201-0138
Fig. 151A SK



201-0139
Fig. 151S
Lower premolars, incisors & roots
for children's
201-0140
Fig. 151 SK

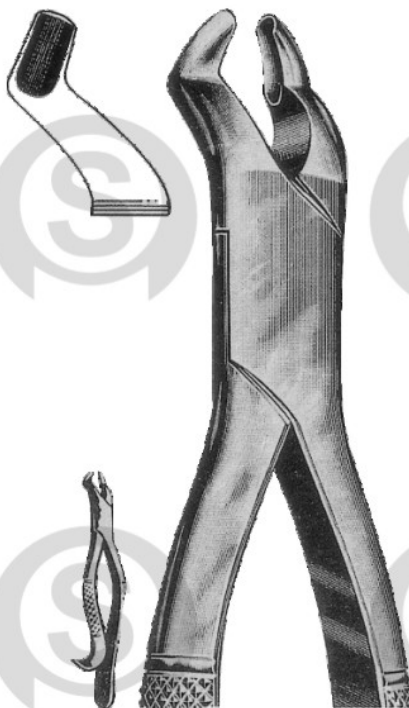

201-0141
Fig. 210H
Upper wisdoms with
hook handle
201-0142
Fig. 210H SK



201-0143
Fig. 210S
Upper wisdoms with
straight handle
201-0144
Fig. 210 SK

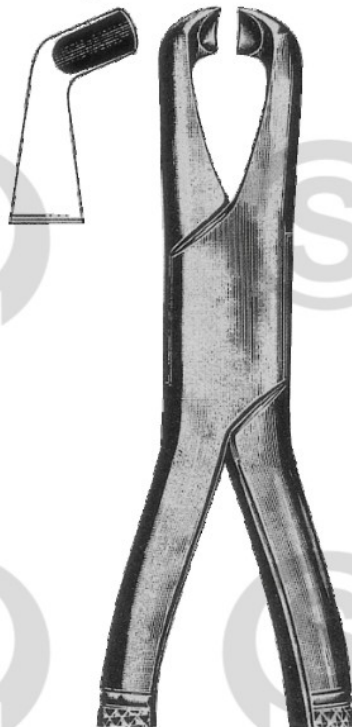

201-0145
Fig. 222
Lower wisdoms
201-0146
Fig. 222 SK

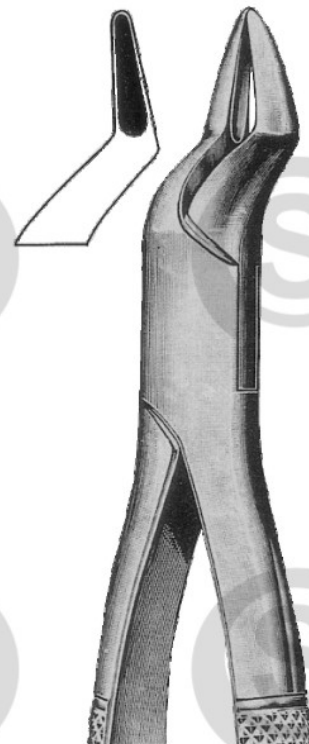

201-0147
Fig. 286
Upper roots, premolars & incisors
20-0148
Fig. 286 SK

EXTRACTING FORCEPS EXTRACTION TWEEZER ●●●



201-0149
Fig. 1
Lower roots

201-0150
Fig. 2
Upper roots



201-0151
Fig. 44
201-0152
Fig. 44 SK



201-0153
Albrecht 16cm



201-0154
Albrecht 16cm

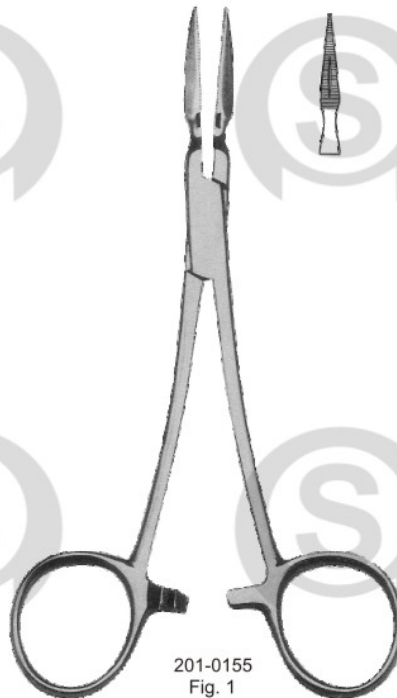

201-0155
Fig. 1
Root fragments



201-0156
Fig. 2
Root fragments



●●● **PLIERS FOR ORTHODONTICS & PROSTHETICS**



202-0001
Waldsachs
15cm



202-0002
Universal
16cm



202-0003
Nance
13.5



202-0004
Aderer
14.5cm

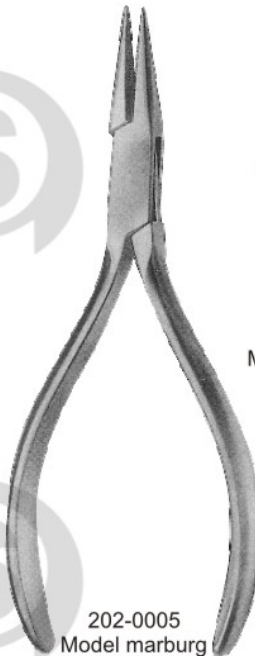

202-0005
Model marburg
Serrated jaws
14cm



202-0006
Model marburg
Smooth jaws
14cm

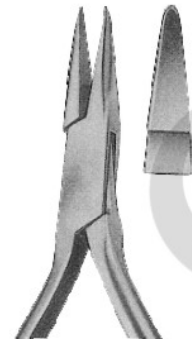

202-0007
Model marburg
Carbid inserts jaws
14cm



202-0008
Goslee
One Serrated jaws
14cm

ASTRO MEDICAL INSTRUMENTS

PLIERS FOR ORTHODONTICS & PROSTHETICS ●●●



202-0009
Flat Pliers
14cm



202-0010
14cm



202-0011
14cm



202-0012
14.5cm



202-0013
14.5cm



202-0014
14cm



202-0015
14cm



202-0016
14cm



202-0017
Serrated jaws
12cm

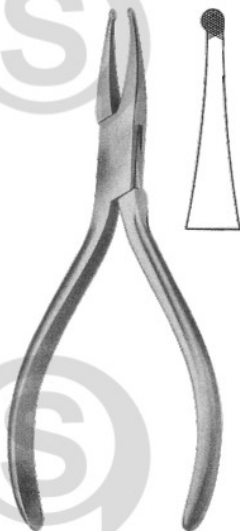

202-0018
How
14.5cm



202-0019
How-angled
14.5cm



202-0020
Arrow clasp forming
12cm



202-0021
Arrow clasp forming
12cm

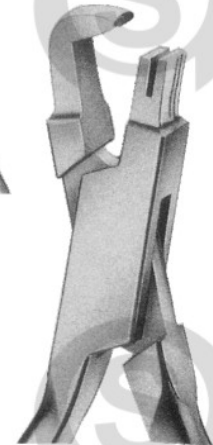

202-0022
Arrow clasp bending
12cm



●●● **PLIERS FOR ORTHODONTICS & PROSTHETICS**

ASTRO MEDICAL INSTRUMENTS



202-0023
Peeso
13.5cm

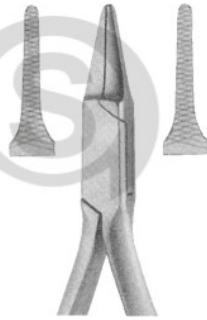

202-0024
Peeso
13.5cm



202-0025
14cm



202-0026
Langenbeck
14cm



202-0027
Jarabak
14cm

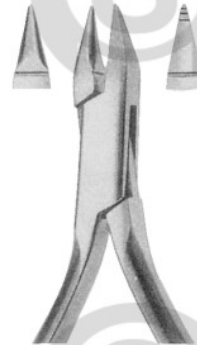

202-0028
Bending Plier
13cm



202-0029
Angle
12.5cm



0.7 mm

1.0 mm



202-0030
Andresen
13cm

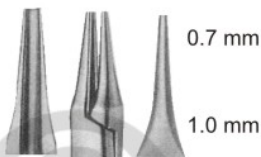

0.7 mm

1.0 mm



202-0031
Bending Plier
13.5cm

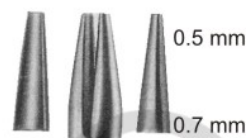

0.5 mm

0.7 mm



202-0032
Schwarz
13.5cm

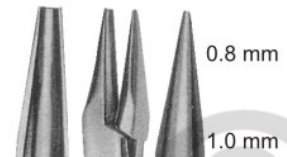

0.8 mm

1.0 mm

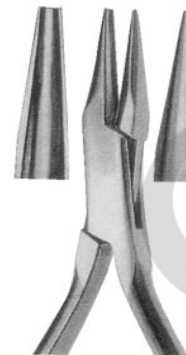

202-0033
Fischer
13cm

PLIERS FOR ORTHODONTICS & PROSTHETICS ●●●

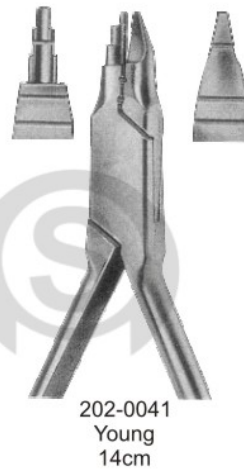



●●● **PLIERS FOR ORTHODONTICS & PROSTHETICS**



202-0043
Hard Wire Cutter
5 1/2" (14 cm)



202-0044
Arch Forming Plier
5 1/2" (14 cm)



202-0045
Medium Size Bending Pliers
5 1/2" (14 cm)



202-0046
Aderer Pliers
5 1/2" (14 cm)



202-0047
Wire Bending Plier
5 1/2" (14 cm)



202-0048
Round & Concave Plier
5 1/2" (14 cm)



202-0049
Aderer Pliers
with narrow standing points,
for bending wires up to \varnothing 0.5mm,
disinfectable, sterilizable
4 3/4" (12cm)



202-0050
Aderer Pliers
for bending wires up to \varnothing 0.9mm,
disinfectable, sterilizable
4 3/4" (12cm)

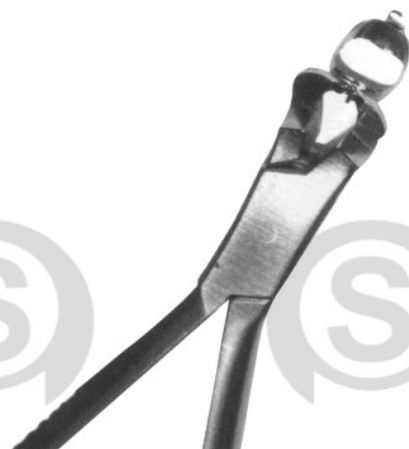

202-0051
Bending plier for lingual cleat
5 1/2" (14cm)

PLIERS FOR ORTHODONTICS & PROSTHETICS ●●●



202-0052
Bracket Removing Pliers
5 1/2" (14 cm)



202-0053
Bracket Removing Pliers
5 1/2" (14 cm)



202-0054
Bracket Removing Pliers
5 1/2" (14 cm)



202-0055
Bracket Removing Pliers
5 1/2" (14cm)



202-0056
Bracket Removing Pliers
5 1/2" (14cm)



202-0057
Flat Pliers
5 1/2" (14 cm)



202-0058
Nance Closing Loop Pliers
5 1/2" (14 cm)



202-0059
Angle Bending Pliers
5 1/2" (14 cm)



202-0060
Crown Crimping Pliers
5 1/2" (14 cm)



●●● **PLIERS FOR ORTHODONTICS & PROSTHETICS**



202-0061
Round & Flat Plier
5 1/2" (14 cm)



202-0062
Tweed Angle Arch Bending
5 1/2" (14 cm)



202-0063
Band Removing Pliers
5 1/2" (14 cm)



202-0064
Johnson Contouring Pliers
5 1/2" (14 cm)



202-0065
Round Nose Pliers
5 1/2" (14 cm)



202-0066
Tweed Angle Arch Bending
5 1/2" (14 cm)



202-0067
De La Rosa Pliers
5 1/2" (14 cm)



202-0068
Arch Forming Plier
5 1/2" (14 cm)



202-0069
Tweed Angle Arch Bending
5 1/2" (14 cm)

ASTRO MEDICAL INSTRUMENTS

PLIERS FOR ORTHODONTICS & PROSTHETICS ●●●

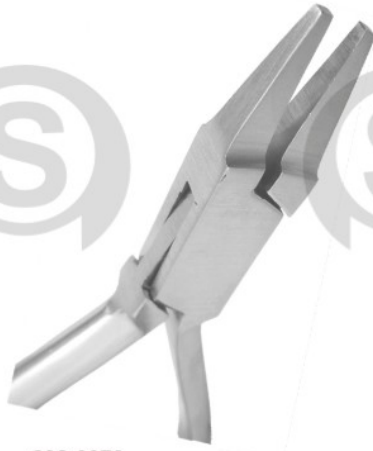

202-0070
Flat Nose Plier
5 1/2" (14 cm)

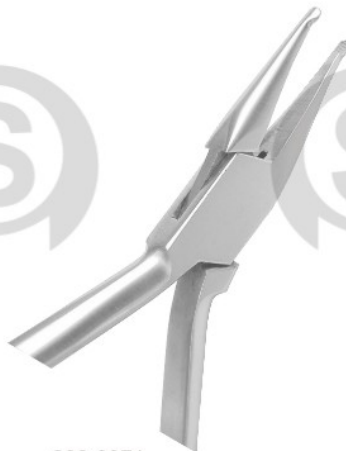

202-0071
How Pliers
5 1/2" (14 cm)



202-0072
Gordon - Contouring
5 1/2" (14 cm)



202-0073
Adams Pliers
5 1/2" (14 cm)



202-0074
Adams Pliers
5 1/2" (14 cm)



202-0075
Tweed Pliers
5 1/2" (14 cm)



202-0076
Bending Pliers
mediumfine, with graduation,
for wires up \varnothing 1.0mm
5 1/2" (14cm)



202-0077
Special pliers
max .022" x .028"
5 1/2" (14cm)



202-0078
Pliers for operating the Mobil-Stop
5 1/2" (14cm)



●●● **PLIERS FOR ORTHODONTICS & PROSTHETICS**



202-0079
Light wire pliers for wires
up to \varnothing 0.60mm
with cutter Begg
4 3/4" (12cm)



202-0080
Weingart Universal Pliers
5 1/2" (14 cm)



202-0081
Weingart ultra lightwire Pliers
5 1/2" (14 cm)



202-0082
Weingart Universal lightwire Pliers
max .022" x .028
5 1/2" (14cm)



202-0083
Universal Facebow Pliers
6 1/2" (16.5cm)

CARBIDE INSERTED PLIERS ●●●



202-0084
Distal Cutter Light Weight
5 1/2" (14 cm)



202-0085
Distal Cutter medium
5 1/2" (14 cm)



202-0086
Ligature Pin Cutter
5 1/2" (14 cm)



201-0087
Hard Wire Cutter
5 1/2" (14 cm)



202-0088
Hard Wire Cutter
5 1/2" (14 cm)



202-0089
Bracket Removing Pliers
5 1/2" (14 cm)

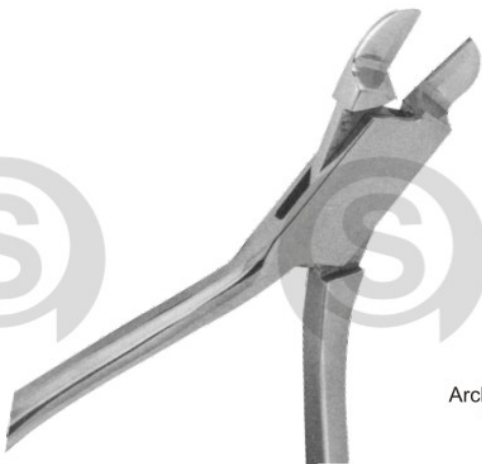

202-0090
Arch torquing and bending pliers
for wires up to \varnothing 0.60mm
allow to user a pair
4 3/4" (12cm)

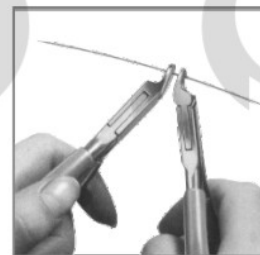



●●● BONE RONGEURS



203-0001
BEYER
150mm (6")
5mm bite



203-0002
JANSEN-MIDDLETON
SEPTUM FORCEPS
200mm (8") Spoon shaped
4mm bite

203-0003
CAIRNS
140mm (5.1/2")
4mm bite

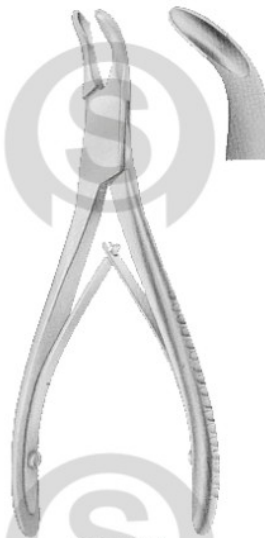

203-0004
CAIRNS
140mm (5.1/2")
4mm bite

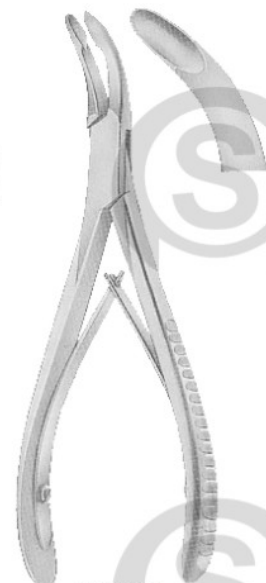

203-0005
LUER
155mm (6")

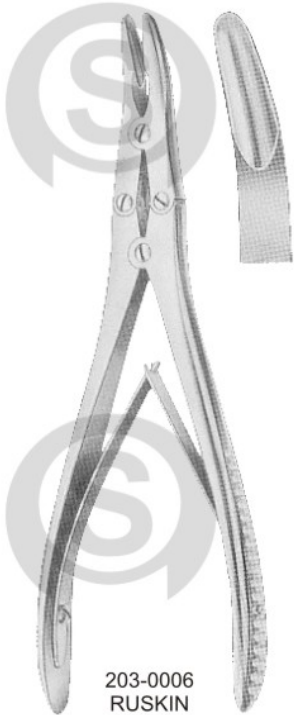

203-0006
RUSKIN
190mm (7.1/2")
6mm bite

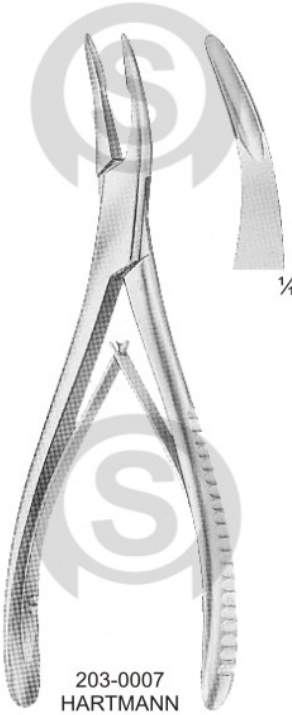

203-0007
HARTMANN
180mm (7")

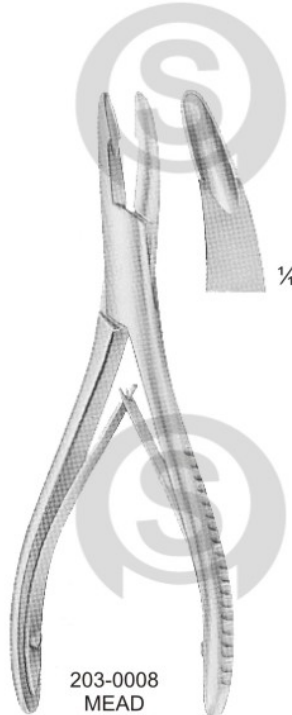

203-0008
MEAD
165mm (6.1/2")

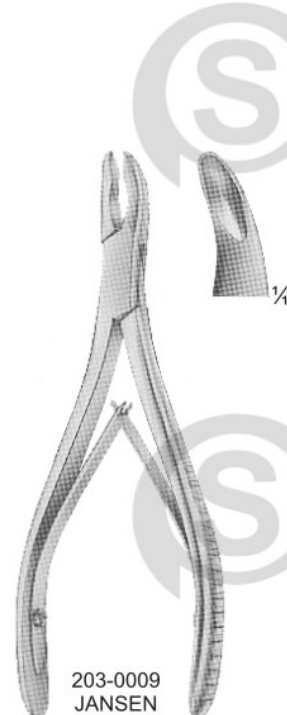

203-0009
JANSEN
150mm (6")

ASTRO MEDICAL INSTRUMENTS

BONE RONGEURS ●●●



203-0010
TROTTER
200mm (8")
10mm bite

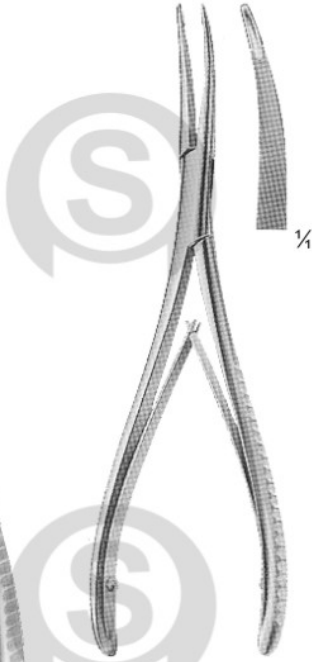

203-0011
SYNOVECTOMY
RONGEUR
175mm (7")



203-0012
HEANLEY
175mm (7")
4mm bite

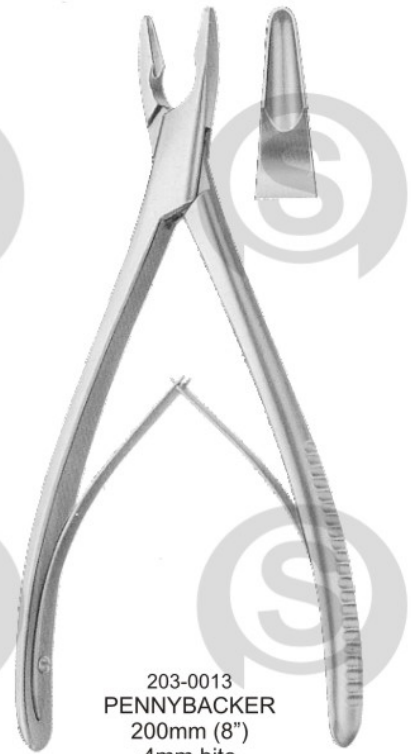

203-0013
PENNYBACKER
200mm (8")
4mm bite



203-0014
SYNOVECTOMY
RONGEUR
130mm (5.1/8")
Jaw width 2mm

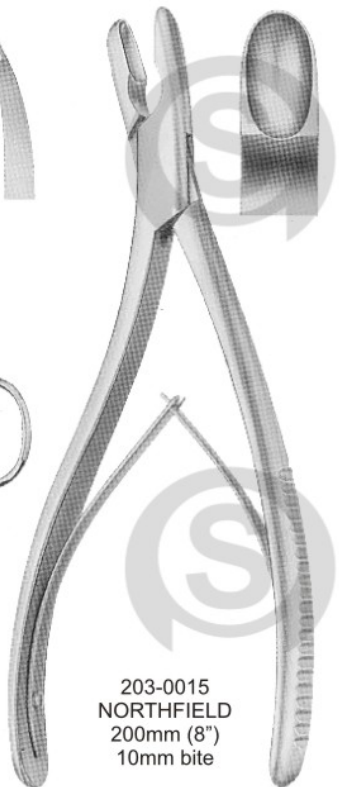

203-0015
NORTHFIELD
200mm (8")
10mm bite

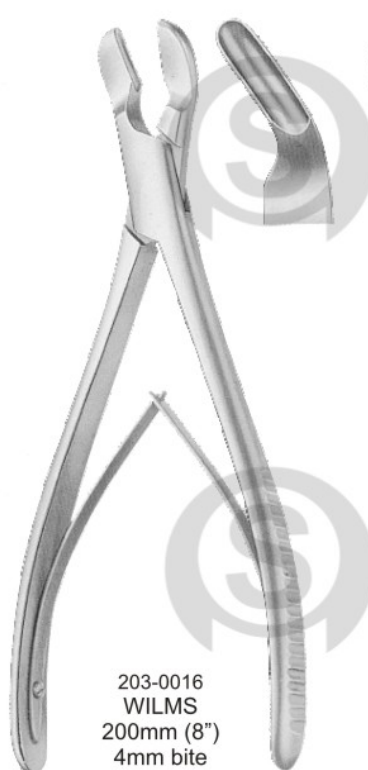

203-0016
WILMS
200mm (8")
4mm bite



LEKSELL
203-0017
240mm
(9.1/2")
6mm bite
203-0018
240mm (9.1/2")
8mm bite



●●● BONE RONGEURS

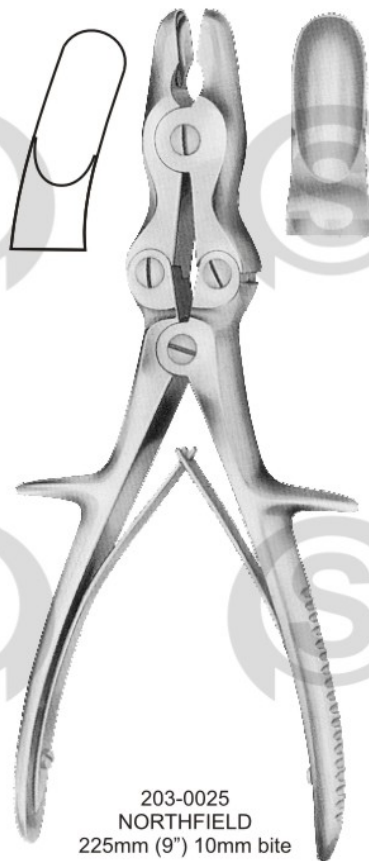

ASTRO MEDICAL INSTRUMENTS

BONE RONGEURS ●●●



203-0026
SARGENT (VAN HAVRE)
220mm (8.3/4")
10mm bite



203-0027
OLIVECRONA
230mm (9")
6mm bite



203-0028
STILLE-RUSKIN
240mm (9.1/2")

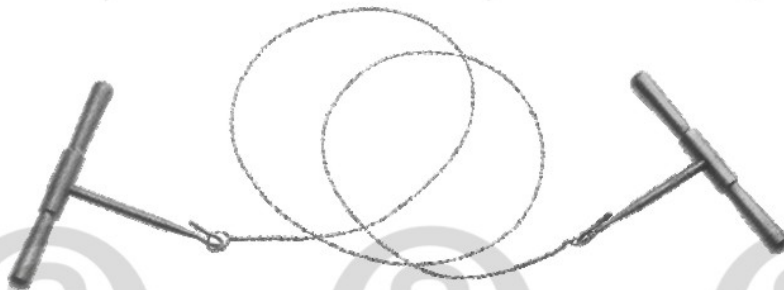

203-0029
GIGLI SAW WITH HANDLE
500mm (20")



203-0030
RUDOR EDWARDS COSTOTOME
230mm (9")



●●● ROOT ELEVATORS

ASTRO MEDICAL INSTRUMENTS

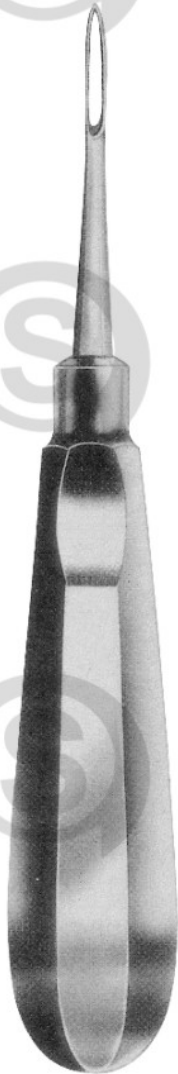

204-0001
Fig. 1B
Bein



204-0002
Fig. 2B
Bein



204-0003
Fig. 3B
Bein



204-0004
Fig. 4B
Bein



204-0005
Fig. 5B
Bein



204-0006
Fig. 6B
Bein



204-0007
Fig. 4SA
Schmeckebeer-Apexo



204-0008
Fig. 5SA
Schmeckebeer-Apexo



204-0009
Fig. 34S
Seldin



204-0010
Fig. 34
Seldin



204-0011
Fig. 2S
Seldin



204-0012
Fig. 3S
Seldin



204-0013
Fig. 1F
Flohr



204-0014
Fig. 2F
Flohr



204-0015
Fig. 3F
Flohr

ROOT ELEVATORS ●●●

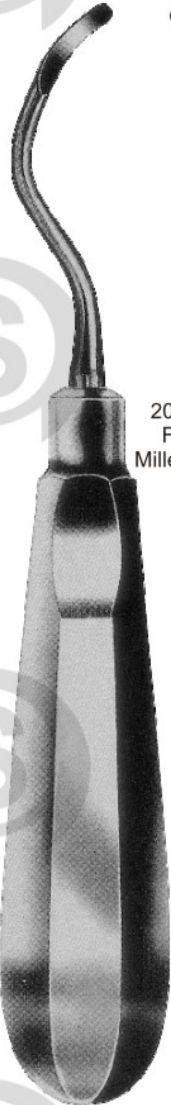

204-0016
Fig. 71
Miller-Apexo



204-0017
Fig. 72
Miller-Apexo



204-0018
Fig. 73
Miller-Apexo



204-0019
Fig. 74
Miller-Apexo



204-0020
Fig. 19



204-0021
Fig. 20



204-0022
Fig. 51
Curtis



204-0023
Fig. 52
Curtis



204-0024
Fig. 1L
Seldin



204-0025
Fig. 1R
Seldin



204-0026
Fig. 4L
Seldin



204-0027
Fig. 4R
Seldin



204-0028
Fig. 11
Stout



204-0029
Fig. 11A
Stout



204-0030
Fig. 44C
Stout

●●● ROOT ELEVATORS



204-0031
Fig. A
Cogswell



204-0032
Fig. B
Cogswell



204-0033
Fig. 301
Apexo



204-0034
Fig. 302
Apexo



204-0035
Fig. 303
Apexo



204-0036
Fig. 301W
Seldin



204-0037
Fig. 304W
Seldin



204-0038
Fig. 1H
Heidbrink



204-0039
Fig. 2H
Heidbrink



204-0040
Fig. 40H
Heidbrink



204-0041
Fig. 41H
Heidbrink



204-0042
Fig. 46



204-0043
Fig. 46R

ROOT ELEVATORS ●●●

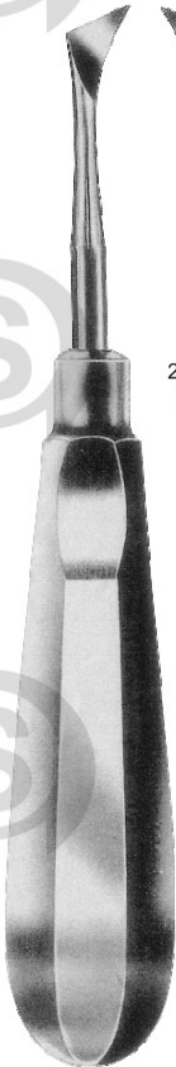

204-0045
Fig. 45
Cryer

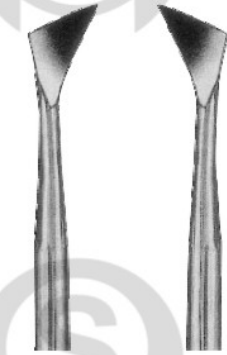

204-0046
Fig. 25
Cryer



204-0047
Fig. 26
Cryer

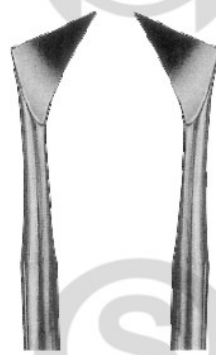

204-0048
Fig. 31
Cryer



204-0049
Fig. 32
Cryer



204-0050
Fig. 80



204-0051
Fig. 81



204-0052
Fig. 81A



204-0053
Fig. 81E



204-0054
Fig. 190



204-0055
Fig. 191



204-0056
Fig. 23



204-0057
Fig. 24



204-0058
Fig. 98

204-0044
Fig. 44
Cryer



●●● ROOT ELEVATORS

ASTRO MEDICAL INSTRUMENTS

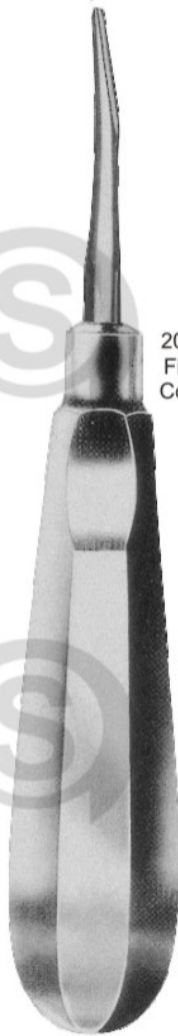

204-0060
Fig. A2C
Coupland



204-0061
Fig. A3C
Coupland



204-0062
Fig. 15
Woodward



204-0063
Fig. 16
Woodward



204-0064
Fig. 1C
Coupland



204-0065
Fig. 2C
Coupland



204-0066
Fig. 3C
Coupland



204-0059
Fig. A1C
Coupland

204-0067
Fig. 11M



204-0068
Fig. 12M



204-0069
Fig. 13M



Mac millan

204-0070
Fig. 8
Crane



204-0071
Fig. 21
University of michigan



204-0072
Fig. 69W
Woodward



204-0073
Fig. 31F
Friedman



204-0074
Fig. 32F
Friedman





ROOT ELEVATORS ●●●

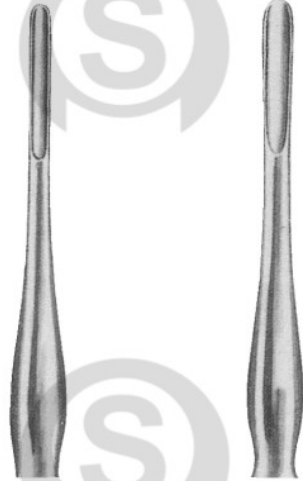

204-0077
Fig. 3
Bein

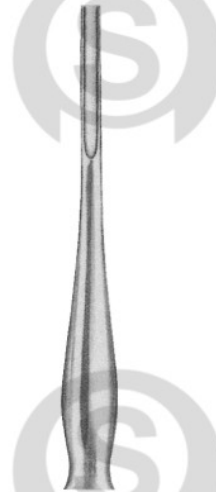

204-0078
Fig. 4
Bein



204-0079
Fig. 5
Bein

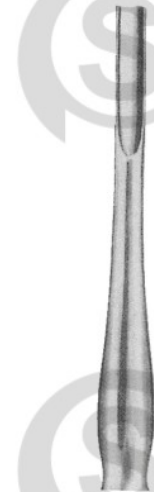

204-0080
Fig. 6
Bein

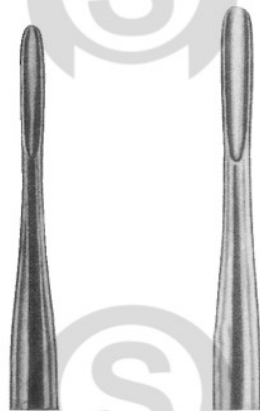

204-0082
Fig. 2

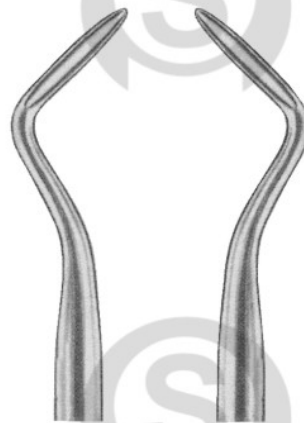

204-0083
Fig. 2
Flohr



204-0084
Fig. 3
Flohr



204-0085
Fig. 3
Cryer

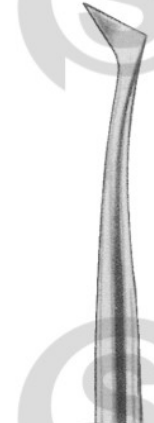

204-0086
Fig. 8
Cryer



●●● ROOT ELEVATORS

ASTRO MEDICAL INSTRUMENTS



204-0087
Walter F. Barry



204-0088
Fig. 320



204-0089
Fig. 321



204-0090
Fig. 322



204-0091
Fig. 323

Walter F. Barry



204-0092
Fig. 1
Heidbrink



204-0093
Fig. 2
Heidbrink



204-0094
Fig. 3
Heidbrink

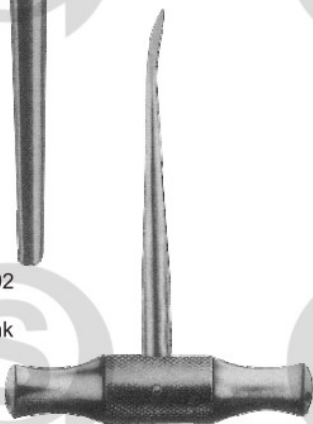

204-0095
Winter

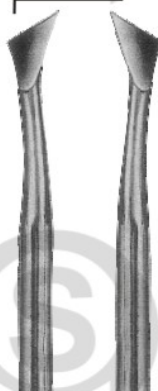

204-0096
Fig. 11LW



204-0097
Fig. 11RW

Winter



204-0098
Fig. 12LW



204-0099
Fig. 12RW

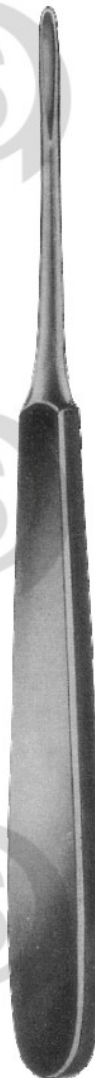

204-0100
Fig. 1
Warwick-james



204-0101
Fig. 2
Warwick-james



204-0102
Fig. 3
Warwick-james

ORTHODONTICS INSTRUMENTS ●●●



205-0001
Band seating &
removing instruments



205-0002

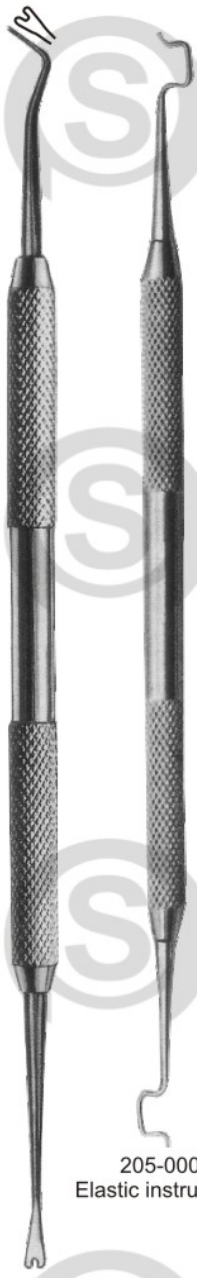

205-0003

205-0004
Elastic instruments

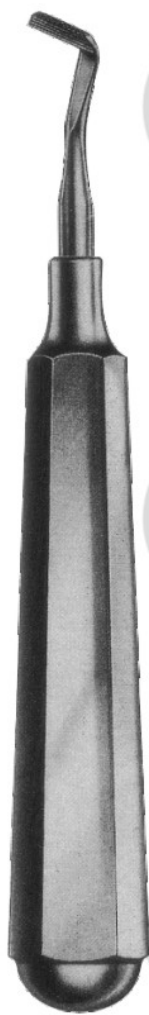

205-0005
Mershon band pusher
14cm



205-0006
Band setter with
tin insert
15cm

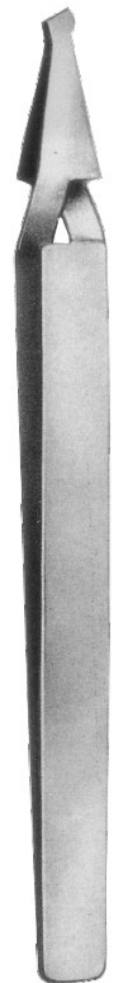

205-0007
13.5 cm



205-0008
14cm

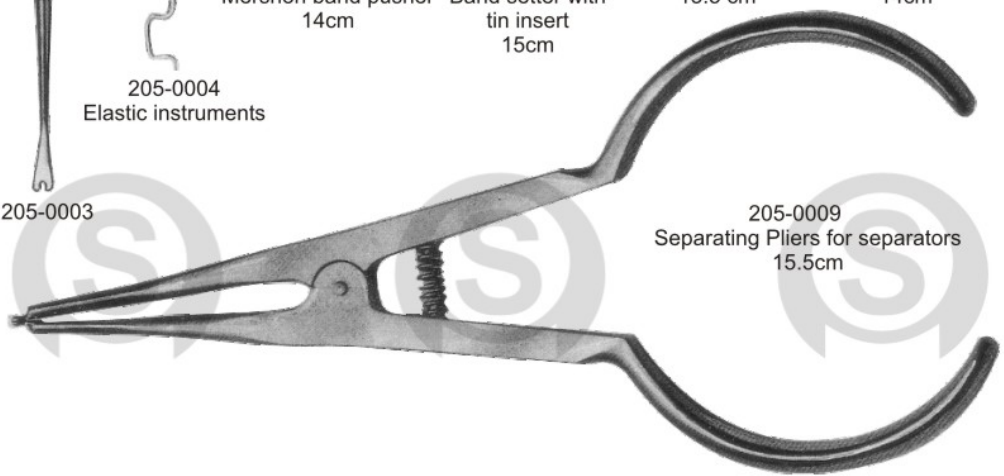

205-0009
Separating Pliers for separators
15.5cm



●●● **ORTHODONTICS INSTRUMENTS**

ASTRO MEDICAL INSTRUMENTS



205-0010
Mathieu pliers
14cm



205-0011
Elastic ligature placing pliers
14cm



205-0012
Mathieu ligating pliers
14cm



205-0013
Mathieu pliers
with finger ring
14cm



205-0014
Straight 5"
Mosquito Forceps
205-0015
Curved 5"



205-0016
Ligature tying piler



205-0017
Bracket positioning gauge

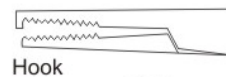

Hook



205-0023
Straight 5"
Mosquito Forceps
205-0024
Curved 5"



205-0018
Bracket placing
tweezer



205-0019
Bracket placing
tweezer



205-0020
Clamping Tweezer



205-0021
Bracket holding
tweezer



205-0022
Band seating
instruments
nylon

GUM SCISSORS ●●●



206-0001
Fig. 1
12cm Straight



206-0002
Fig. 2
12cm curved

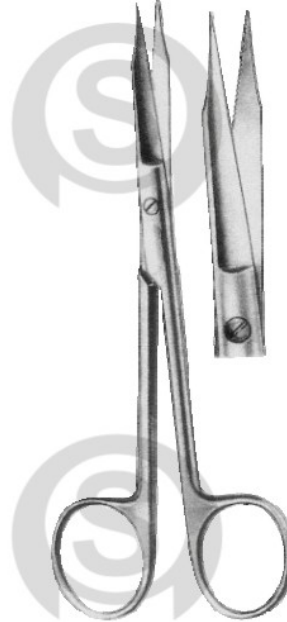

206 -0003
Fig 1
13cm
Goldman-Fox
Saw edge
Straight



206-0004
Fig 2
13cm
Goldman-Fox
Saw edge
curved



206-0005
Fig. 1
11.5cm
Iris Straight



206-0006
Fig. 2
11.5cm
Iris
Curved



206-0007
Fig. 3
11.5cm
Iris



206-0008
Fig. 1
11.5cm
Angular Saw edge



206-0009
Fig. 2
11.5cm
Angular



●●● GUM SCISSORS

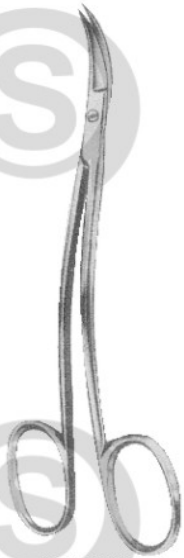

206-0010
Fig. 1
La Grange
11.5cm

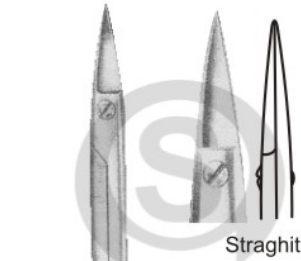

206-0011
Fig. 1
Quinby
12.5cm

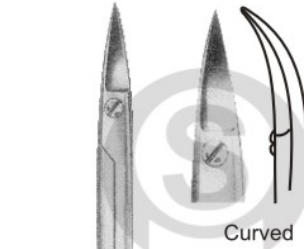

206-0012
Fig. 2
Quinby
12.5cm

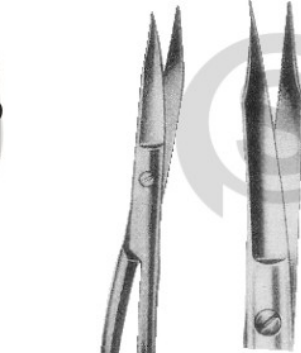

206-0013
Fig. 3
Goldman-Fox (Special)
saw edge
12.5cm

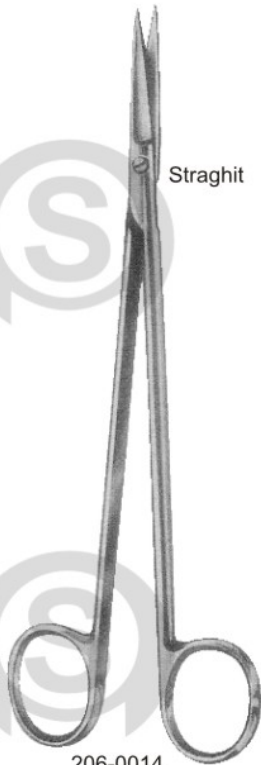

206-0014
Fig. 1
Kelly
16cm



206-0015
Fig. 2
Kelly
16cm



206-0016
Fig. 1
Locklin
16.5 cm



206-0017
Fig. 2
Locklin
16.5cm

SURGICAL SCISSORS ●●●

Very fine points

Very fine points



206-0018
Fig. 1
Noyes (Castroaviejo)
12cm

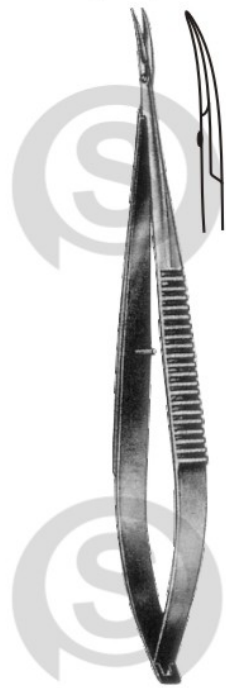

206-0019
Fig. 1
14.5cm

Blunt points

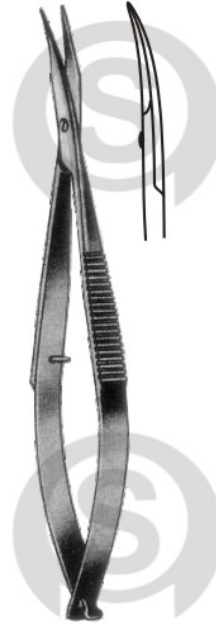

206-0020
Fig. 1
Westcott
11cm

Sharp points



206-0021
Fig. 2
Westcott
11cm



206-0022
Fig. 1
Spencer
9cm

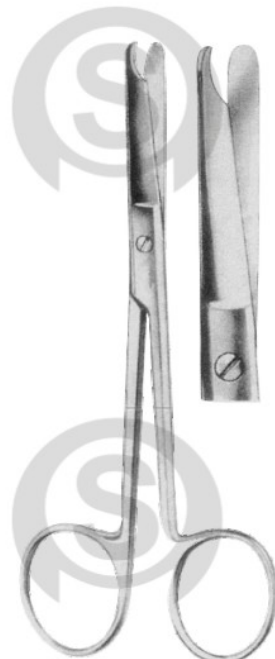

206-0023
Fig. 2
Spencer
13cm

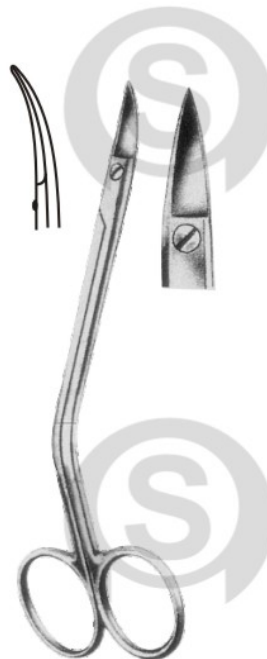

206-0024
Fig. 1
Neumann
12.5cm

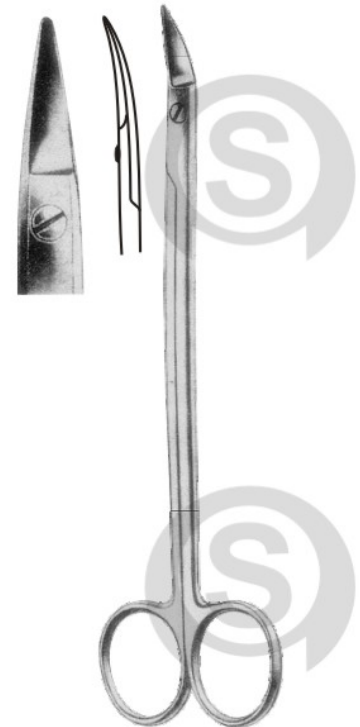

206-0025
Fig. 1
Dean
17cm



●●● **SURGICAL SCISSORS**



Straight

206-0026
Fig. 1
Mayo
14.5cm

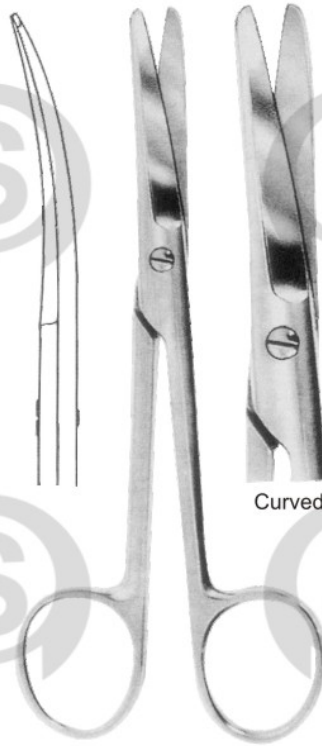

Curved

206-0027
Fig. 2
Mayo
14.5cm

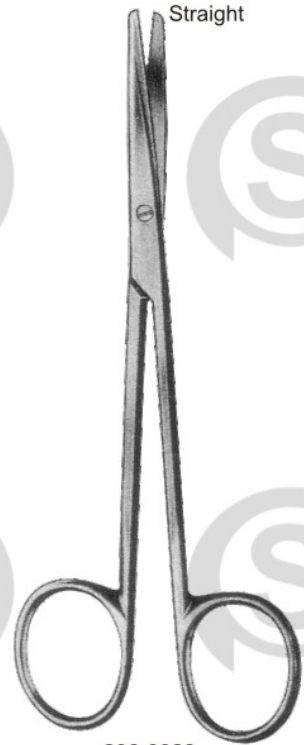

Straight

206-0028
Fig. 2
Metzenbaum
14.5cm

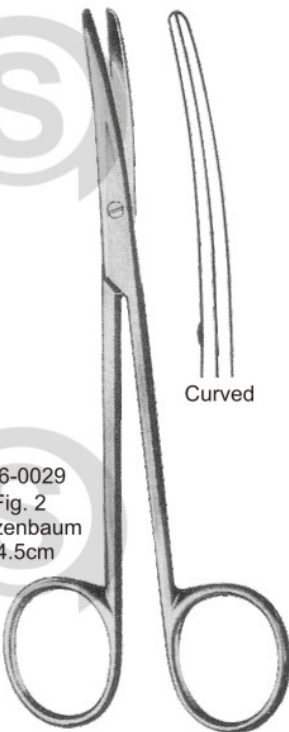

Curved

206-0029
Fig. 2
Metzenbaum
14.5cm



Straight

206-0030
Fig. 2
Metzenbaum-delicate
14.5cm

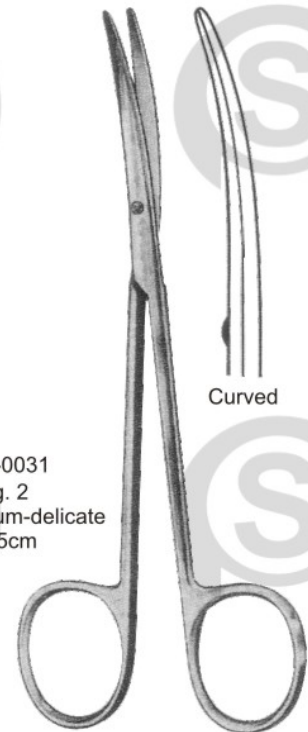

Curved

206-0031
Fig. 2
Metzenbaum-delicate
14.5cm

HAEMOSTATIC FORCEPS ●●●

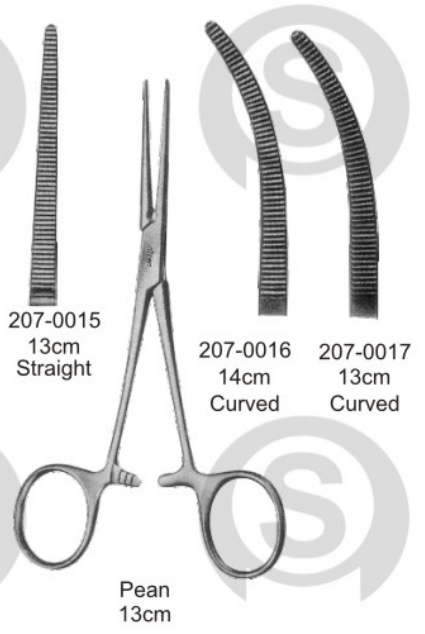
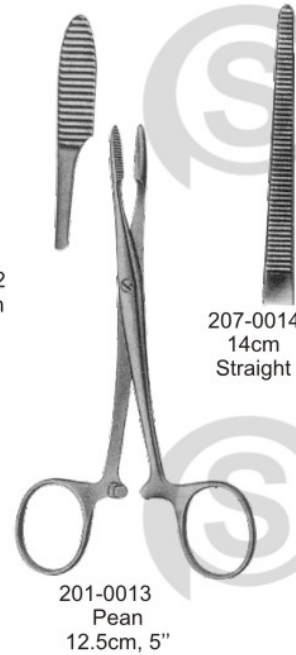
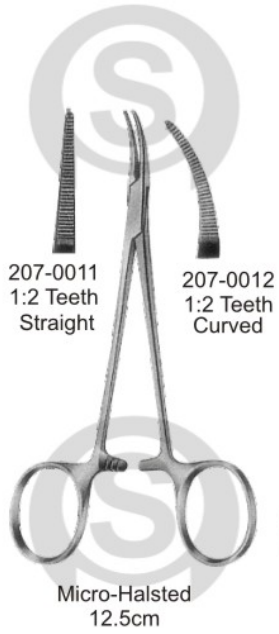
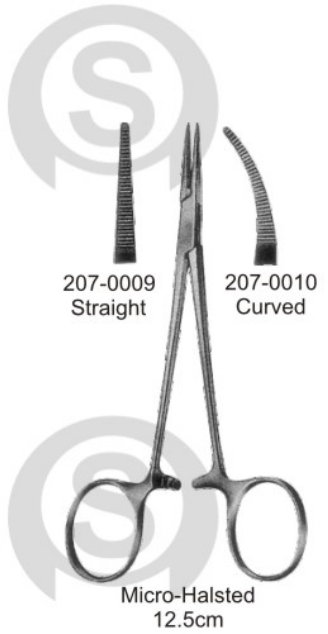
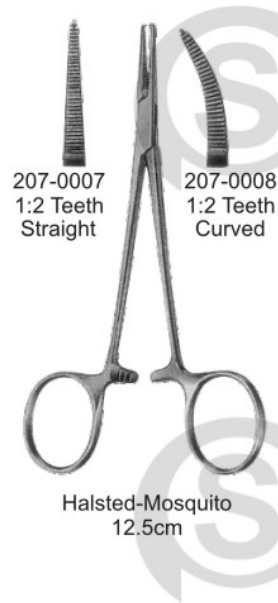
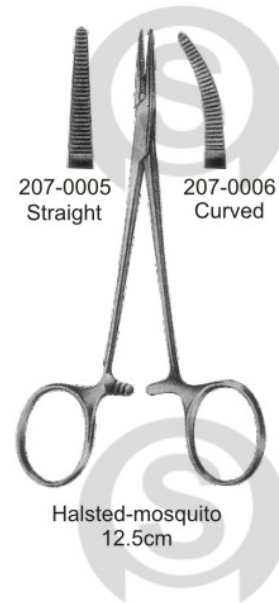
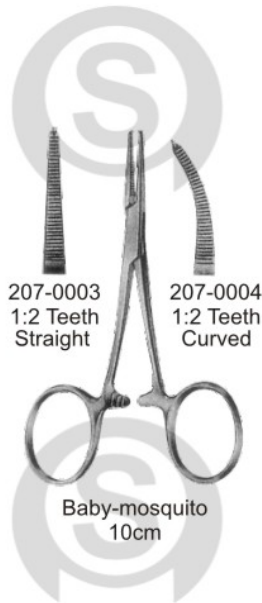

ASTRO MEDICAL INSTRUMENTS



●●● HAEMOSTATIC FORCEPS

ASTRO MEDICAL INSTRUMENTS

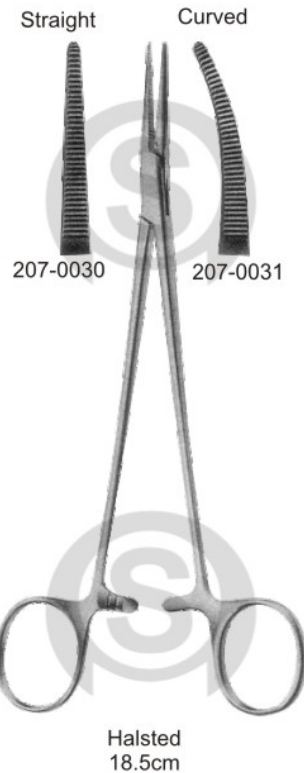
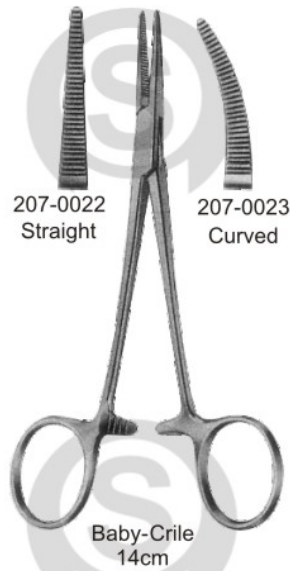
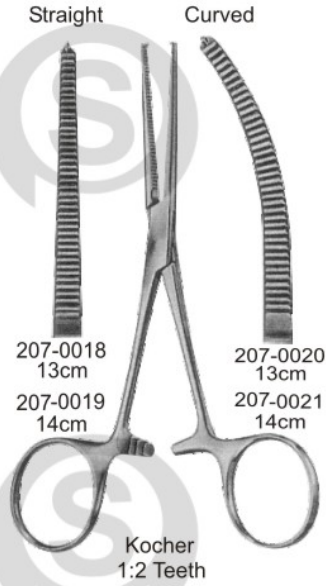

SPONGE AND DRESSING FORCEPS ●●●



207-0035
Without Ratchet
14.5cm



207-0036
With Ratchet
14.5cm



207-0037
Curved
17.5cm



207-0038
Curved
21cm

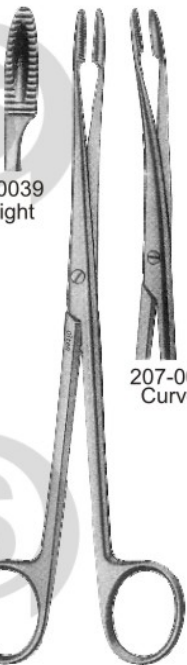

207-0039
Straight

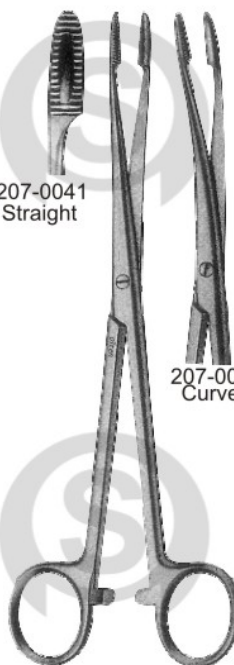

207-0041
Straight

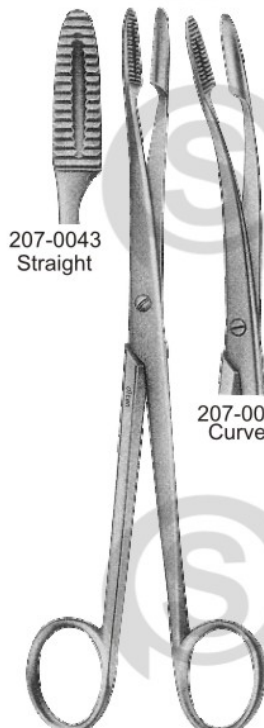

207-0043
Straight

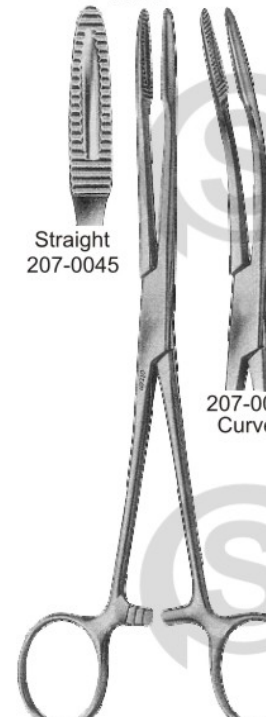

Straight
207-0045

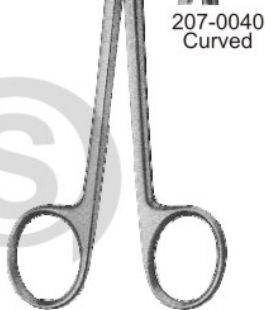

207-0040
Curved

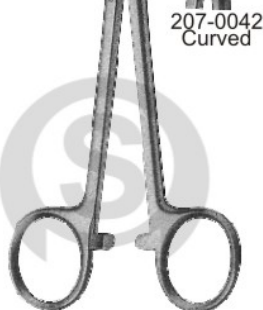

207-0042
Curved

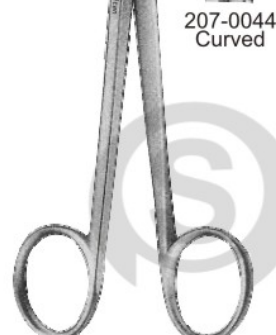

207-0044
Curved



207-0046
Curved

Without Ratchet
18cm

With Ratchet
18cm

Without Ratchet
20cm

With Ratchet
20cm



●●● **TOWEL CLAMPS** Sterilizing Forceps For Sterile Instruments



207-0063
8 cm

Backhaus

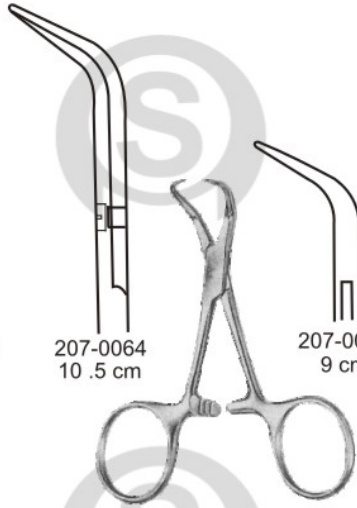

207-0064
10.5 cm

Backhaus



207-0065
9 cm



207-0066
11 cm

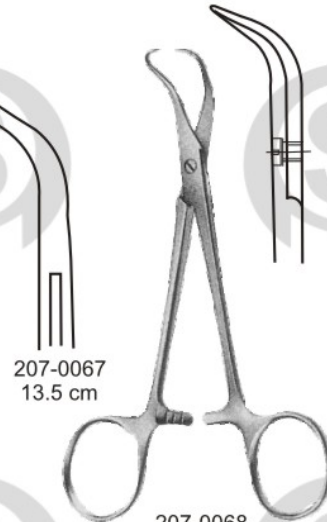

207-0067
13.5 cm

207-0068
Backhaus-Kocher
13.5cm



207-0069
16cm



207-0070
Cheatle
28cm

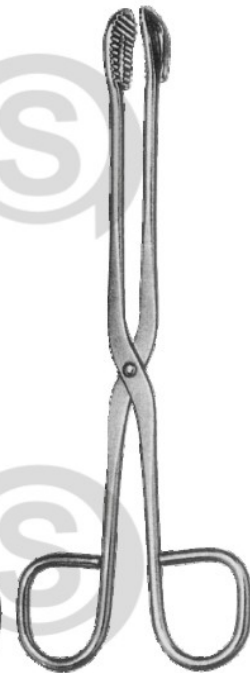

207-0071
20cm

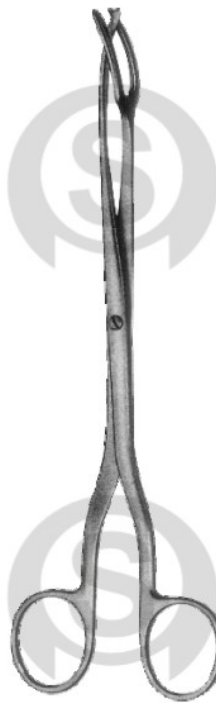

207-0072
20cm, 8"
30cm, 12"



207-0073
Rogge
23,5cm

ASTRO MEDICAL INSTRUMENTS

SKIN HOOK & RETRACTORS ●●●



208-0001
Frazier
13cm



208-0002
Gillies
18cm



208-0003



208-0004



208-0005
Graefe
12.5cm



208-0006



208-0007



208-0008
Kilner
16cm



208-0009



208-0010
3mm



208-0011
6mm



208-0012
8mm

joseph
16.5cm



208-0013
Bergmann
14cm



208-0014
Freer
15cm



208-0015
Fomon
14.5cm



Blunt



208-0017



208-0018



208-0016
Williger
12cm

●●● **RETRACTORS**

ASTRO MEDICAL INSTRUMENTS



208-0019
Small Curve Sharp
16.5cm



208-0024
Small Curve Blunt
16.5cm



208-0025

208-0026

208-0027

208-0028



208-0029
Flexible Shaft, Sharp
15.5cm



208-0032
Blunt



208-0034



208-0036
16×6mm



208-0037
25×6mm



11×13 mm

Strandell-Stille
18cm

Rrtractors
16cm

Langenbeck-Green
16cm

208-0038
16cm

208-0033
Toothed

208-0035

RETRACTORS ●●●

25×10mm
22×10mm

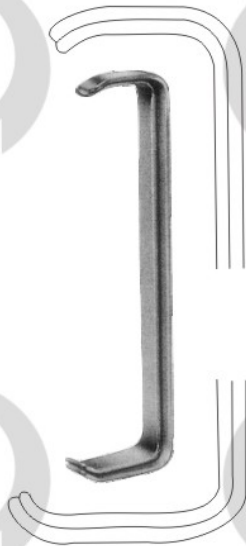

28×12mm
32×12mm
208-0039
Farabeuf (Set of 2Pcs)
12.5cm

23×16mm
20×16mm

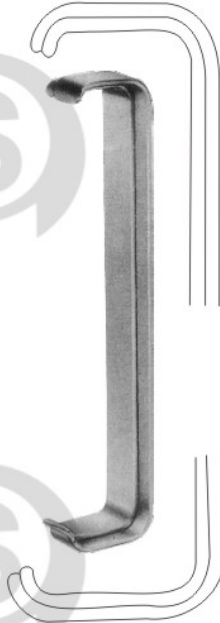

24×16mm
28×16mm
208-0040
Farabeuf (Set of 2Pcs)
15cm



208-0041 19×22mm
23×30mm
208-0042 25×26mm
28×38mm
208-0043 28×29mm
33×45mm



Farabeuf (Set of 3Pcs)
16.5cm



208-0044
30×10mm

208-0045
40×10mm



208-0046
43×13mm



Langenbeck
23cm



208-0047
25×6mm

208-0048
35×8mm

208-0049
35×11mm

208-0050
35×15mm

208-0051
41×11mm

208-0052
55×11mm



Kocher-Langenbeck
21.5cm



●●● CHEEK RETRACTORS



Middeldorpf



208-0053
15×15mm
22cm



208-0054
20×22mm
21.5cm



208-0055
28×28mm
23.5cm



208-0056
Greene
22.5cm



208-0057
Buchs
20.5cm



208-0058
28×10mm



208-0059
28×14mm



208-0060
33×14mm



208-0061
28×16mm

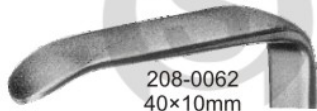

208-0062
40×10mm

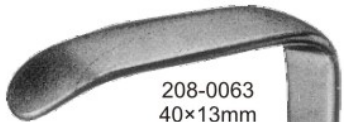

208-0063
40×13mm



Langenbeck
21cm

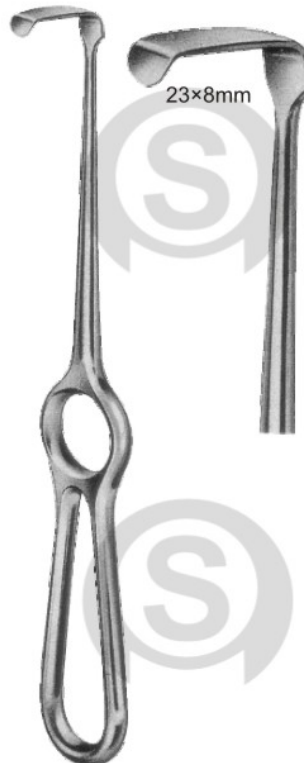

208-0064
Kocher
21cm



208-0066
Blunt

208-0065
Alm (Sharp)
7cm

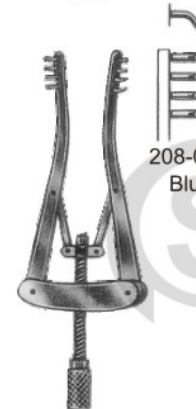

208-0067
Alm (Sharp)
10cm

208-0068
Blunt

5mm

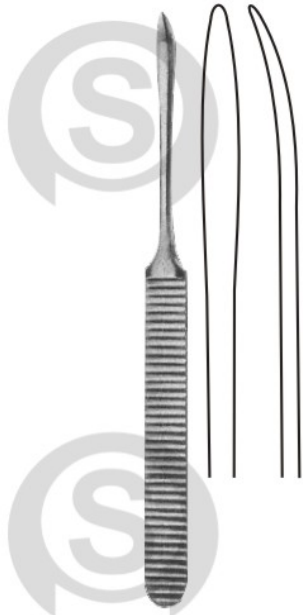

208-0069
Williger
16.5cm

6mm

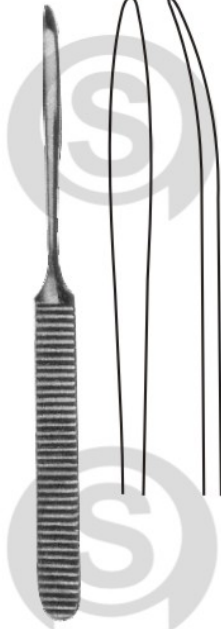

208-0070
Williger
17cm

4.5mm

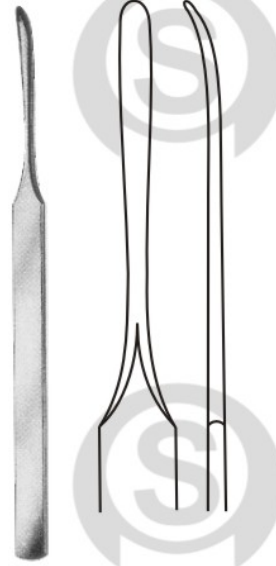

208-0071
Konig
15.5mm

4.5mm



208-0072
Konig
15.5cm



208-0073
Freer
19cm



208-0074
Freer
18.5cm

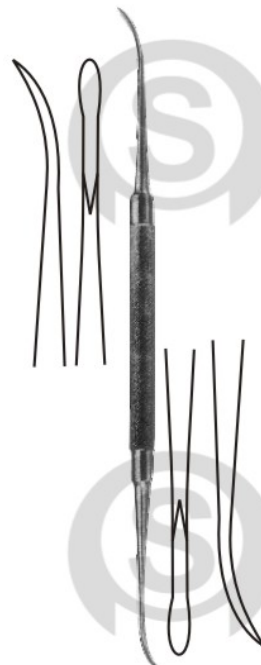

208-0075
Freer-Yasargil
18.5cm

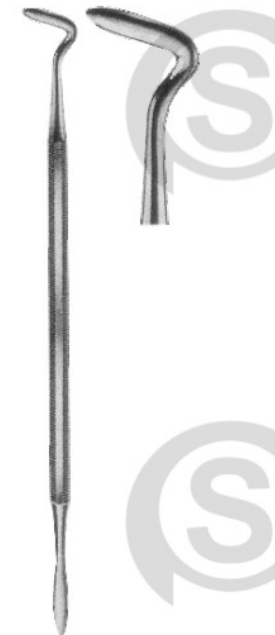

208-0076
Kendzia
17cm



●●● **ELEVATORS**

ASTRO MEDICAL INSTRUMENTS

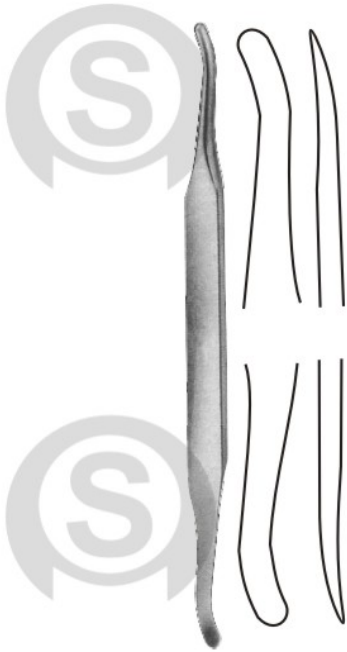

208-0077
Scladin
19.5cm

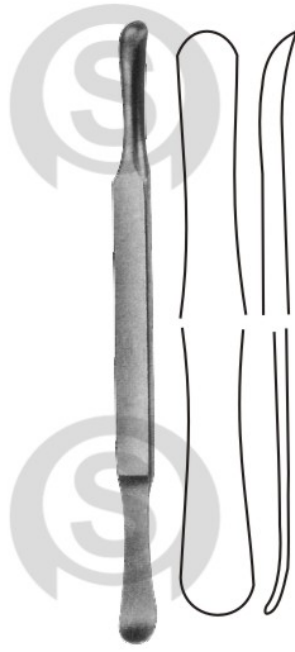

208-0078
Scladin
19.5cm



208-0079
Chompret
15cm

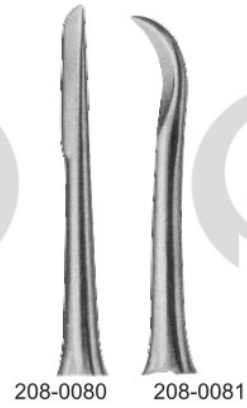

208-0080 208-0081

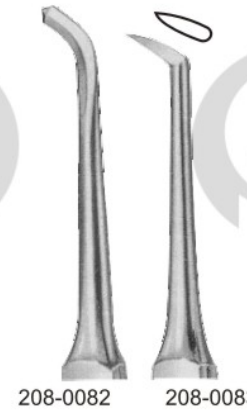

208-0082 208-0083



208-0084
Freer
16cm



208-0085
Freer
16cm



208-0086
Partsch, mod
14.5cm

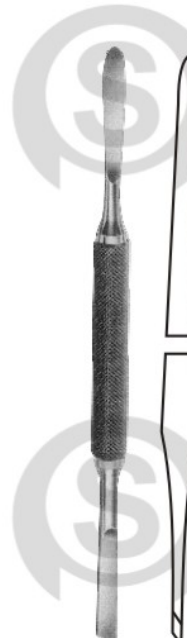

208-0087
Mead
16.5cm

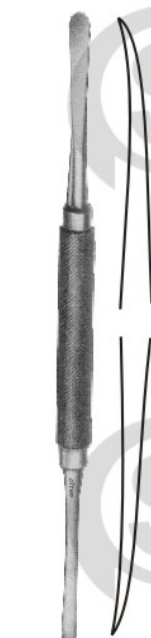

208-0088
Mead
18cm

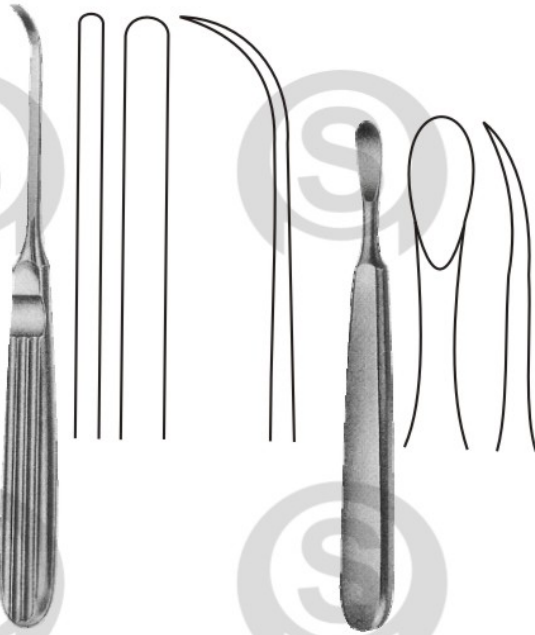

208-0089 (3m)
208-0090 (6mm)
Raspatories
17cm

208-0091
8mm
Trelat
14cm



208-0092
Konig
15.5cm

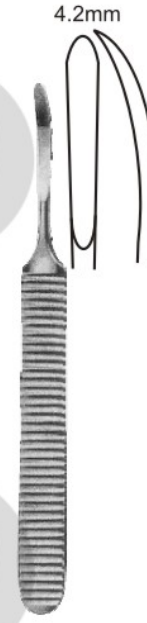

208-0093
Williger
14cm

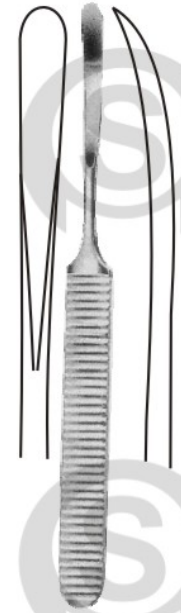

208-0094
Williger
16cm

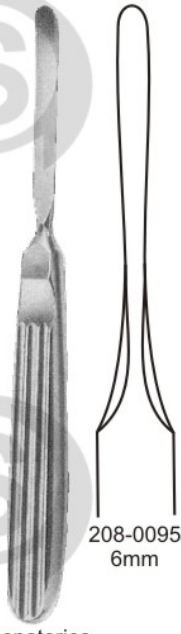

Raspatories
16.5cm

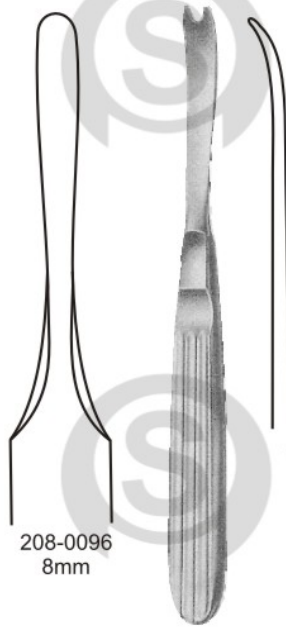

208-0097
Obwegeser
17cm



9mm Sharp



Raspatories
20cm



208-0098
5mm



208-0099
8mm



208-0100
Tessie
22cm



●●● CHISELS & GOUGES

ASTRO MEDICAL INSTRUMENTS

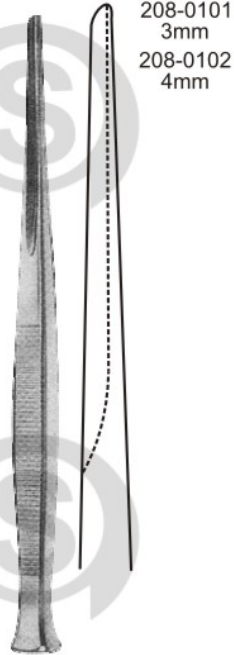

Partsch
17cm

208-0101
3mm
208-0102
4mm



208-0103
Freer
16cm

4mm



208-0104
Freer
16cm

4mm
Curved



Lucas
16cm

208-0105
4mm
208-0106
6mm



Lucas
16cm

208-0107
3mm
208-0108
5mm

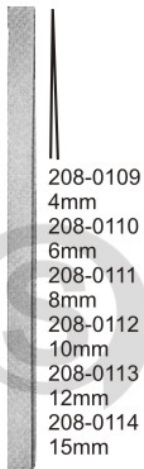

Lambotte
12.5cm

208-0109
4mm
208-0110
6mm
208-0111
8mm
208-0112
10mm
208-0113
12mm
208-0114
15mm



14cm

208-0115
4mm
208-0116
6mm
208-0117
8mm

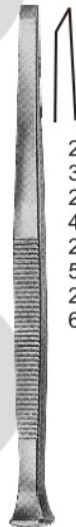

Partsch
14cm

208-0118
3mm
208-0119
4mm
208-0120
5mm
208-0121
6mm

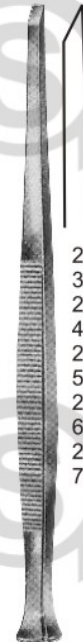

Partsch
17cm

208-0122
3mm
208-0123
4mm
208-0124
5mm
208-0125
6mm
208-0126
7mm



Partsch
14cm

208-0127
3mm
208-0128
4mm

RUBBER DAM INSTRUMENTS ●●●

Calmp forceps



209-0001
Ivory light weight
17cm

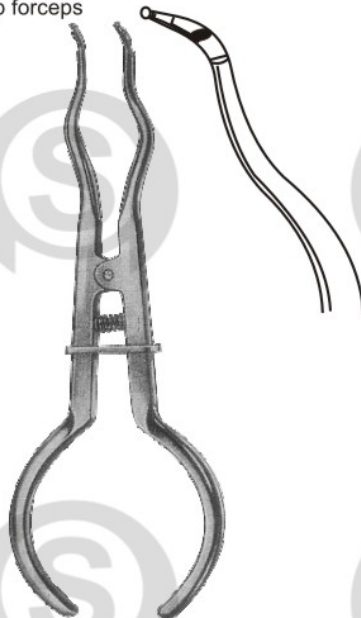

209-0002
Brewer
17.5cm

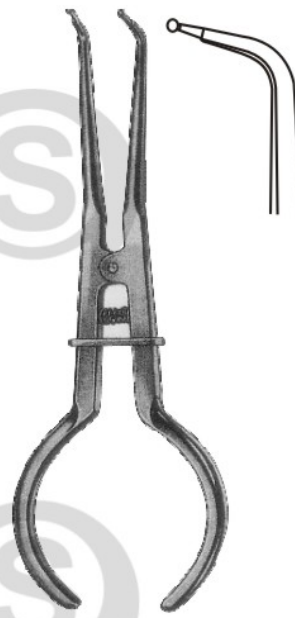

209-0003
Stokes
17.5cm

Punch forceps



209-0004
Ainsworth
17cm



209-0005
Ivory
17cm

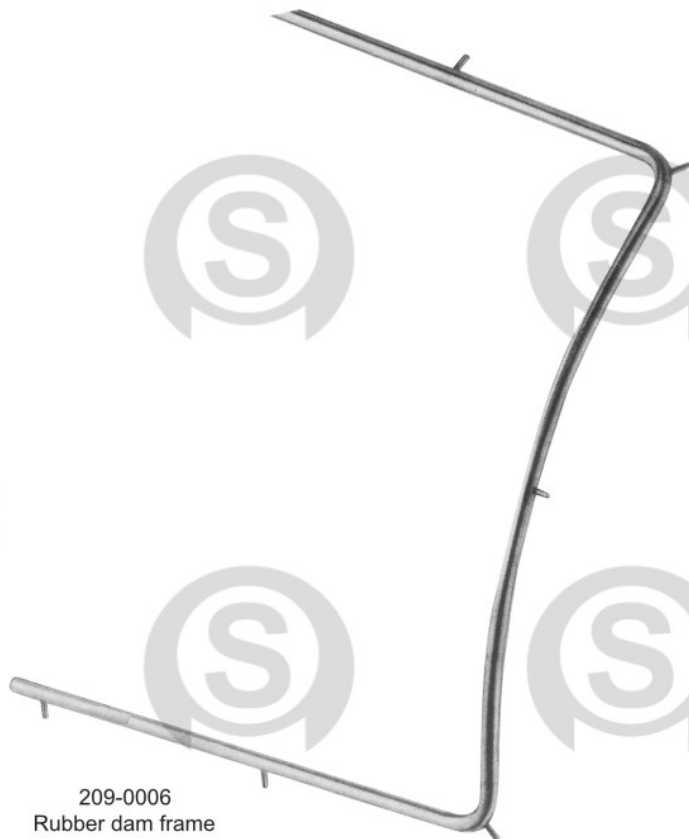

209-0006
Rubber dam frame



●●● **TISSUE PLIERS**

210-0001
Adson, 12cm



210-0002
Adson1x2, 12cm

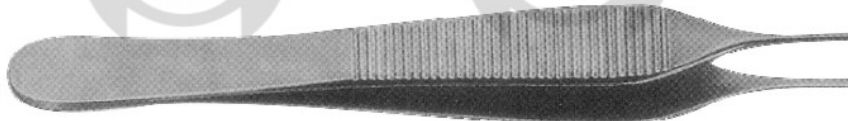

210-0003
Fig. 1
Semken-Taylor
12.5 cm



210-0004
Fig. 2
Semken-Taylor
12.5cm

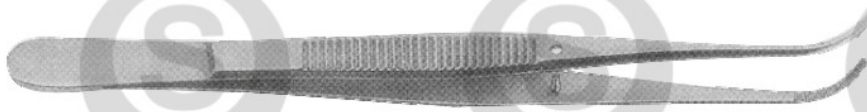

210-0005
Fig. 1
Semken-Taylor 1x2
12.5cm



210-0006
Fig. 2
Semken-Taylor 1x2
12.5cm

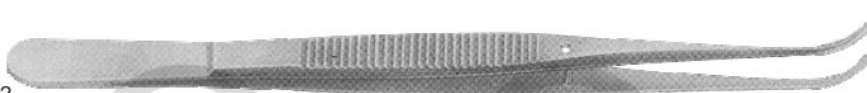

210-0007
12cm



210-0008
11.5cm



210-0009
11.5cm



210-0010
11.5cm

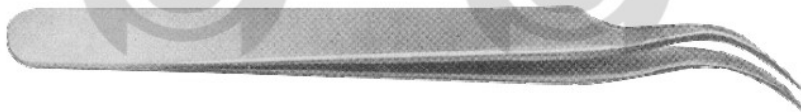

COTTON AND DRESSING PLIERS ●●●

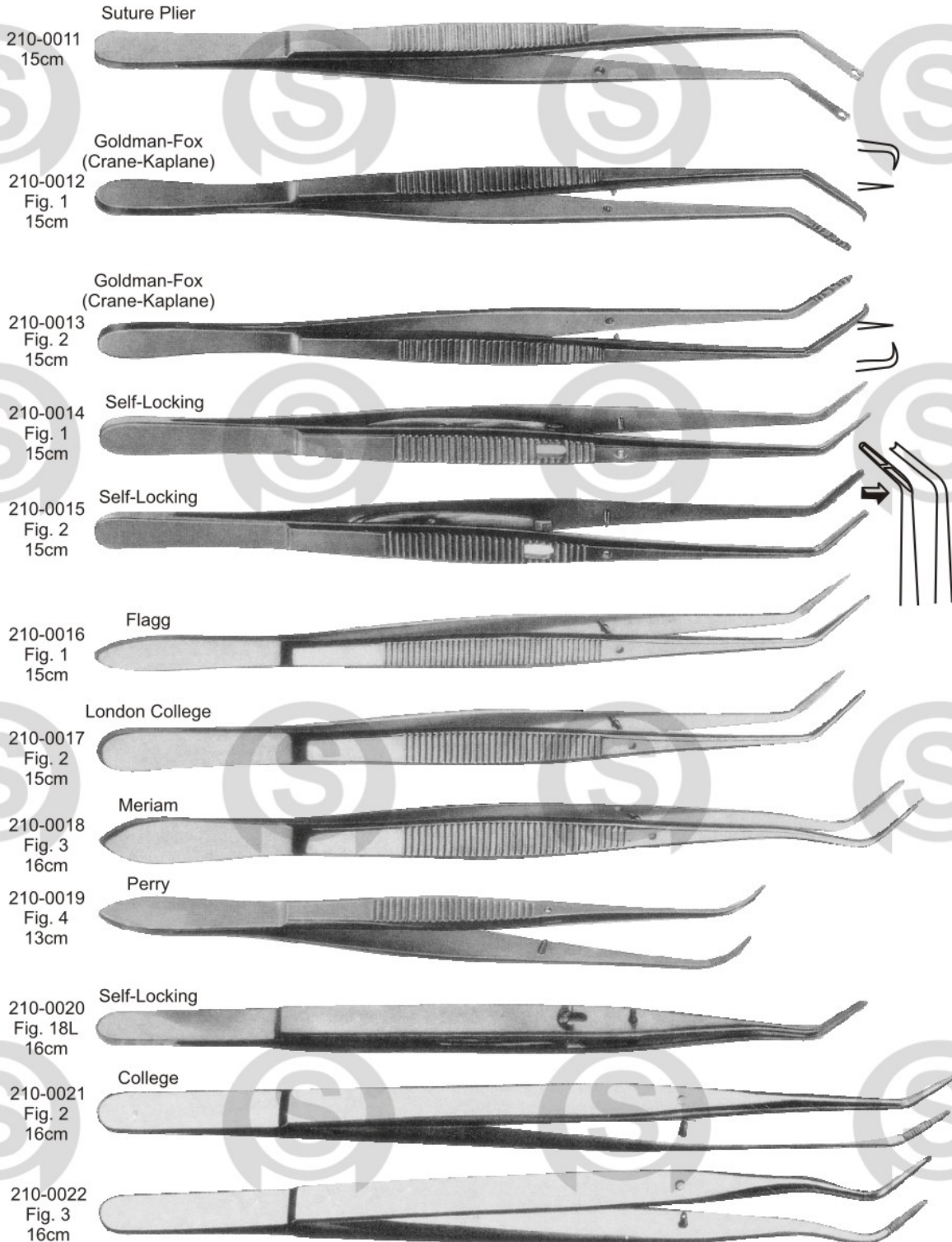



●●● SCALPEL HANDLES

ASTRO MEDICAL INSTRUMENTS

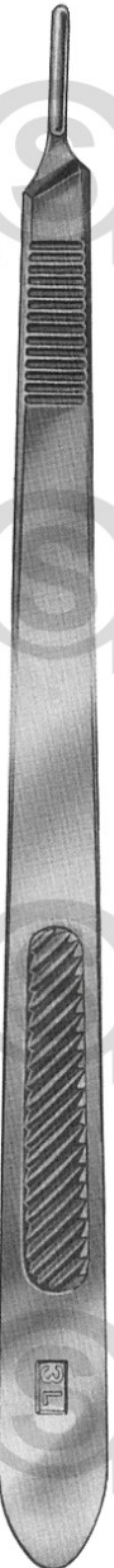

211-0001
No.3L

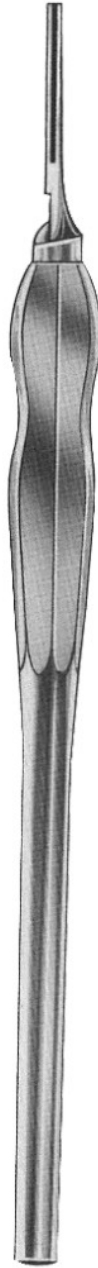

211-0002
ERGONOMIC



211-0003
No.7

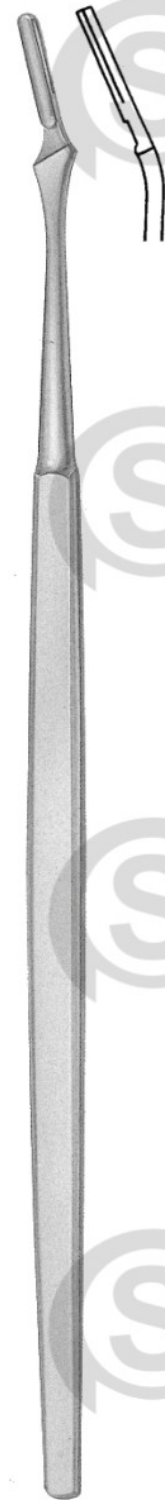

211-0004



211-0005

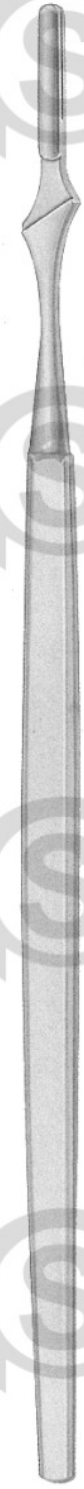

211-0006

SCALPEL HANDLES ●●●

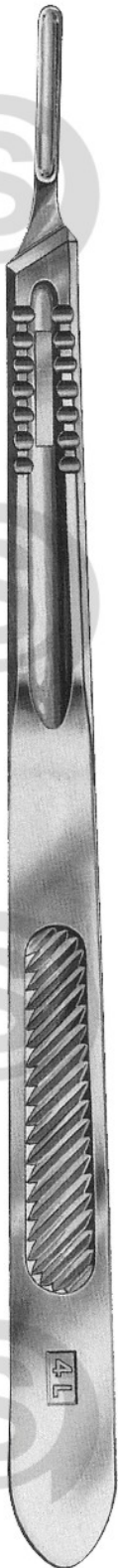

211-0007
No.4L

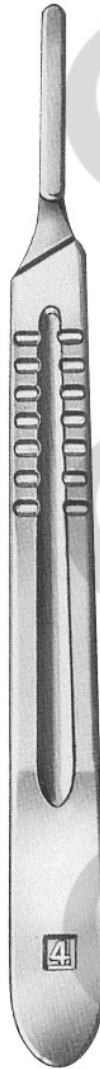

211-0008
No.4

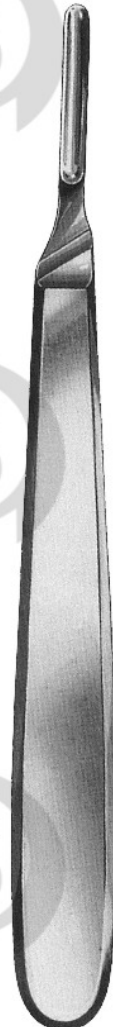

211-0009
No.10

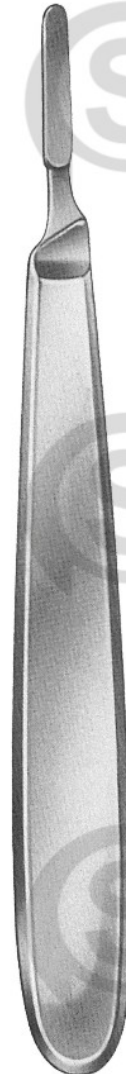

211-0010
No.9



211-0011
No. 3



211-0012
BARRON
For "B.P." type blades
for use with No's
10,11,12 & 15 blades
135mm (5.1/4")



●●● HANDLES REFERENCE GUIDE

ASTRO MEDICAL INSTRUMENTS



211-0013
Single ended
Knurling round



211-0014
Double ended
Knurling round



211-0015
Single ended
octangle serrated



211-0016
Double ended
octangle serrated



211-0017
Single ended
hollow round



211-0018
Double ended
hollow round



211-0019
Double ended
hollow round grooved



211-0020
Double ended
swiss pattern octangle

MICRO, NEEDLE HOLDERS ●●●



212-0001
CASTROVIEJO
145mm (5.3/4")
With catch



212-0002
CASTROVIEJO
145mm (5.3/4")
With catch



212-0003
ARRUGA
135mm (5.1/4")



212-0004
BARRAQUER
120mm (4.3/4")
With catch



212-0005
BARRAQUER
120mm (4.3/4")
Without catch

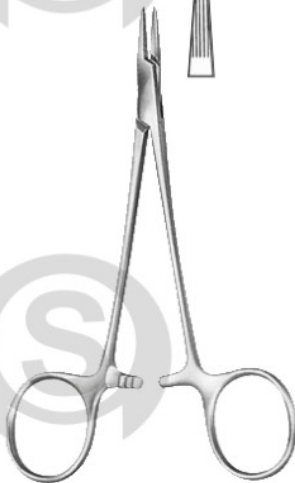

212-0006
CONVERSE
125mm (5")



212-0007
DERF
120mm (4.3/4")



212-0008
MAYO (DUNHILL)
160mm (6.1/4")



212-0009
MAYO
180mm (7")



●●● NEEDLE HOLDERS



212-0010
MAYO
190mm (7.1/2")



212-0011
CRILE WOOD
150mm (6")



212-0012
CRILE MURRAY
145mm (5.3/4")



212-0013
KILNER
135mm (5.1/4")



NAUNTON MORGAN

212-0014
190mm (7.1/2")
212-0015
250mm (10")



WANGENSTEEN

212-0016
270mm (10.3/4")

ASTRO MEDICAL INSTRUMENTS

NEEDLE HOLDERS ●●●



212-0017
JAMESON
230mm (9")



212-0018
WRIGHT
125mm (5")



212-0019
GILLIES
Combined needle holder
and scissors
160mm (6.1/4")

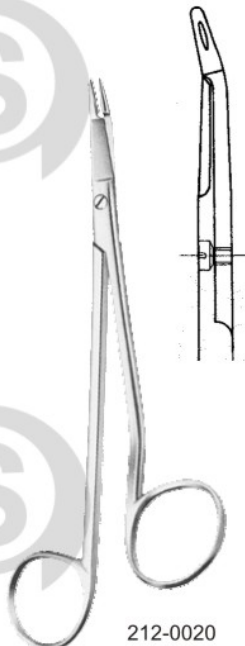

212-0020
WARD
Combined needle holder
and scissors
180mm (7")



212-0021
HEANEY
200mm (8")

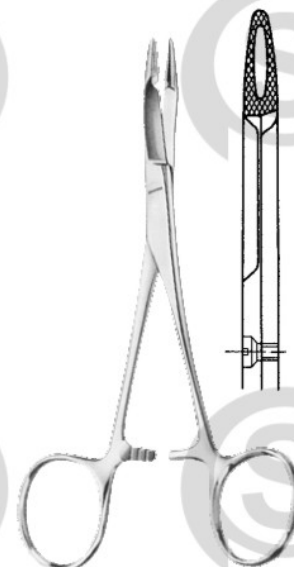

OLSEN HEGAR
Combined needle holder
and scissors
212-0022 140mm (5.1/2")
212-0023 165mm (6.1/2")
212-0024 190mm (7.1/2")

●●● NEEDLE HOLDERS

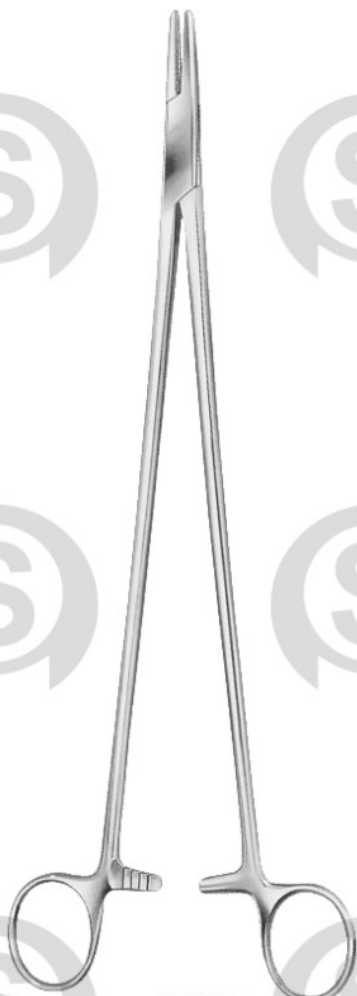

MAYO



212-0025
MAYO (BAUMGARTNER)
140mm (5.1/2")



212-0026
MAYO (MASSON)
265mm (10.1/2")



212-0027
MAYO
65mm (6.1/2")



212-0028
190mm (7.1/2")



212-0029
200mm (8")



212-0030
230mm (9")



212-0031
HEGAR
200mm (8")



212-0032
HALSEY
125mm (5")



212-0033
MATHIEU
140mm (5.1/2")

NEEDLE HOLDERS ●●●



212-0034
MATHIEU
170mm (6.3/4")



212-0035
MATHIEU
200mm (8")



212-0036
WEBSTER
Smooth Jaw
115mm (4.1/2")



212-0037
MAYO
150mm (6")



212-0038
MCPHAILS
180mm (7")



LAWRENCE
212-0039 150mm (6")
Lightweight
212-0040 150mm (6")



●●● MOUTH MIRRORS



212-0041
Plane -4



212-0042
Plane -5



212-0043
Magnifying-4



212-0044
Magnifying-5



212-0045
Front Surface-4

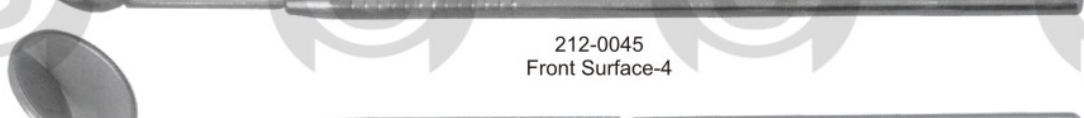

212-0046
Front Surface-5



212-0047



212-0048
Hollow



212-0049
Hollow



212-0050
Hollow



212-0051
Hollow



212-0052
Hollow

EXPLORERS ENDODONTIC INSTRUMENTS ●●●



213-0001
Fig. 23



213-0002
Fig. 2



213-0003
Fig. 16



213-0004
Fig. 9



213-0005
Fig. 10



213-0006
Fig. 12



213-0007
Fig. 11



213-0008
Fig. 6



213-0009
Fig. 8



213-0010
Fig. 5



213-0011
Fig. 17



213-0012
Fig. 17A



213-0013
Fig. 3



213-0014
Fig. 3A



213-0015
Fig. 1
Spreader



213-0016
Fig. 2
Spreader



213-0017
Fig. 3
Spreader



213-0018
Fig. 4
Spreader



213-0019
Fig. 5
Spreader



213-0020
Fig. 6
Spreader



213-0021
Fig. 7
Spreader



●●● **EXPLORERS** PROBES

ASTRO MEDICAL INSTRUMENTS

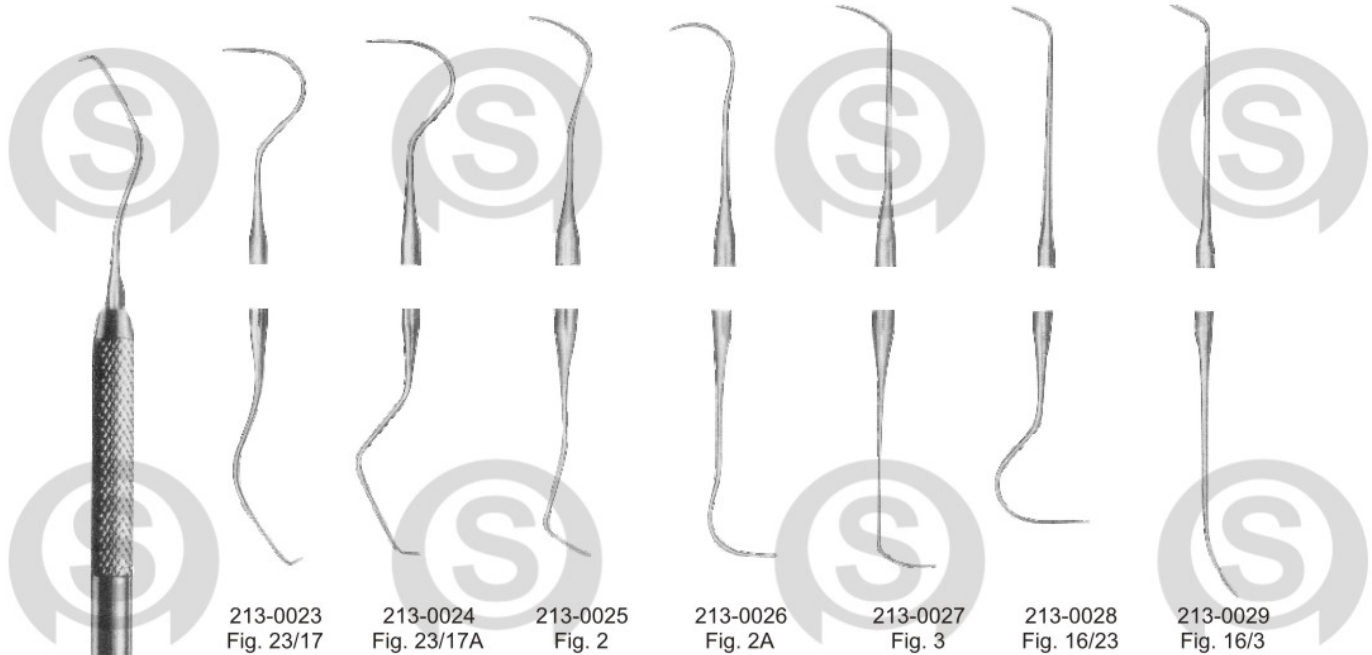

213-0023
Fig. 23/17

213-0024
Fig. 23/17A

213-0025
Fig. 2

213-0026
Fig. 2A

213-0027
Fig. 3

213-0028
Fig. 16/23

213-0029
Fig. 16/3

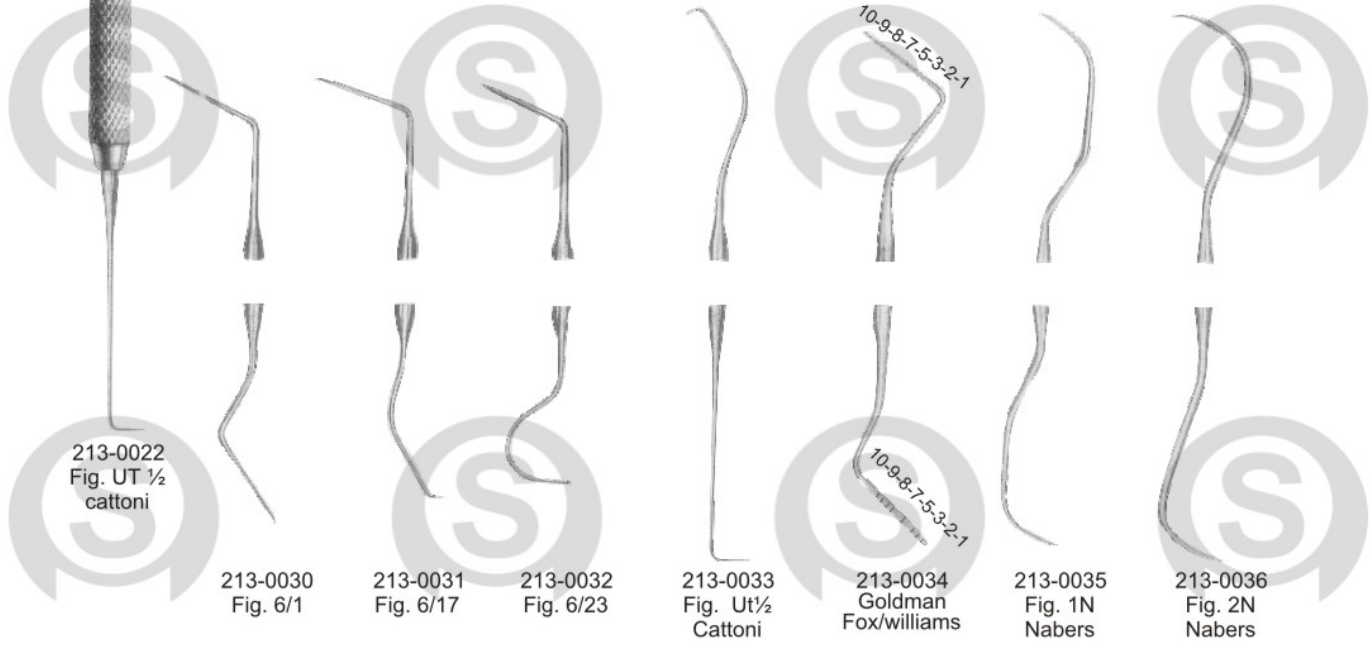

213-0022
Fig. UT 1/2
cattoni

213-0030
Fig. 6/1

213-0031
Fig. 6/17

213-0032
Fig. 6/23

213-0033
Fig. Ut 1/2
Cattoni

213-0034
Goldman
Fox/williams

213-0035
Fig. 1N
Nabers

213-0036
Fig. 2N
Nabers

Root canal explorers

EXPLORERS ENDODONTIC INSTRUMENTS ●●●

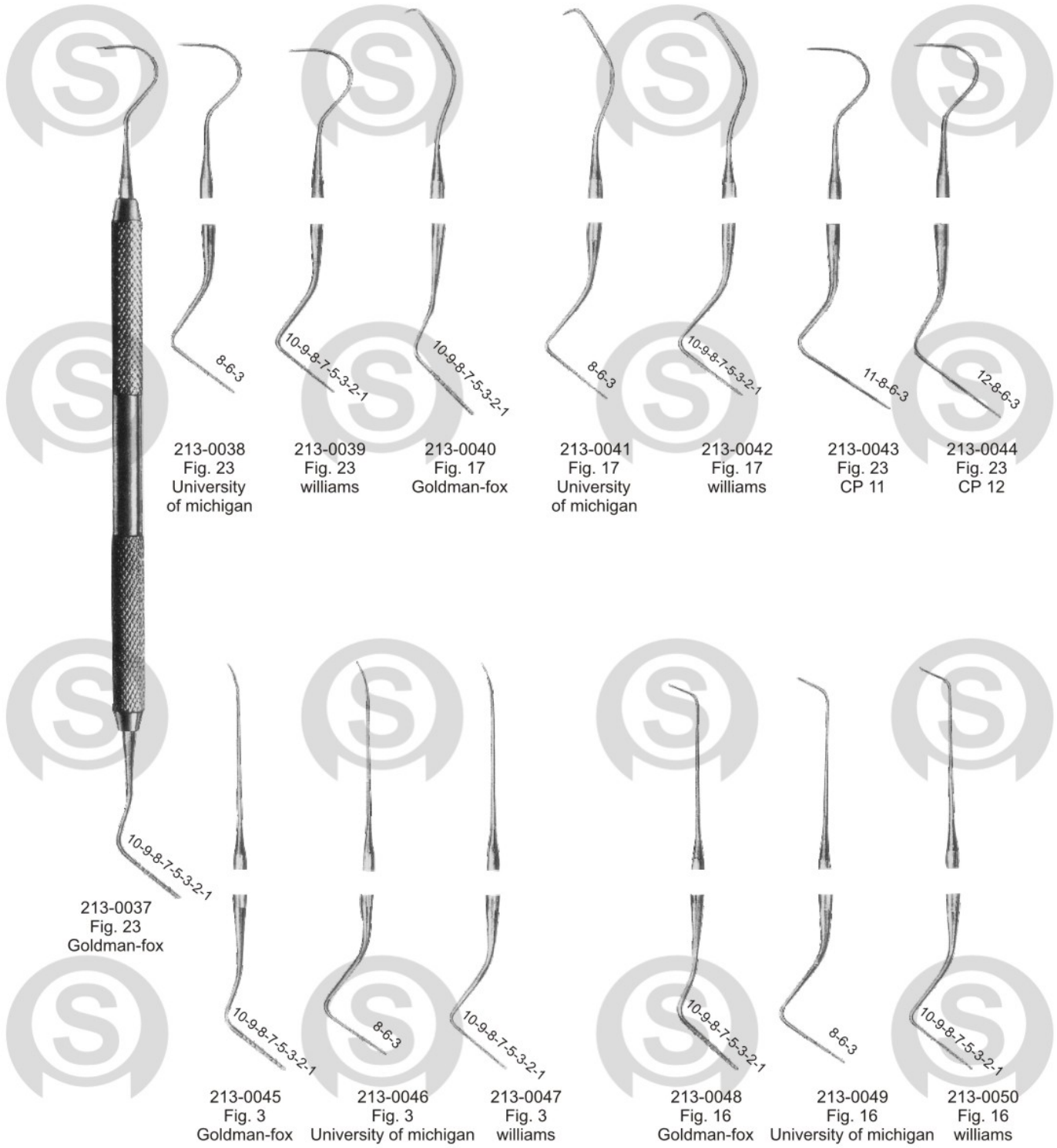

213-0038
Fig. 23
University of michigan

213-0039
Fig. 23
williams

213-0040
Fig. 17
Goldman-fox

213-0041
Fig. 17
University of michigan

213-0042
Fig. 17
williams

213-0043
Fig. 23
CP 11

213-0044
Fig. 23
CP 12

213-0037
Fig. 23
Goldman-fox

213-0045
Fig. 3
Goldman-fox

213-0046
Fig. 3
University of michigan

213-0047
Fig. 3
williams

213-0048
Fig. 16
Goldman-fox

213-0049
Fig. 16
University of michigan

213-0050
Fig. 16
williams

●●● PERIODONTAL POCKET PROBES ENDODONTIC INSTRUMENTS

ASTRO MEDICAL INSTRUMENTS



213-0051
Williams



213-0052
Williams



213-0053
Marrit A



213-0054
Marrit B

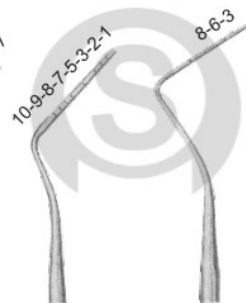

213-0055
Goldman
Fox



213-0056
University
of michigan



213-0057
26 G



213-0058
CP-12S
O.M.S



213-0059
CP-11



213-0060
CP-12

Color - coded



213-0061
Fig. 1
Luks



213-0062
Fig. 2
Luks



213-0063
Fig. 3
Luks



213-0064
Fig. 4
Luks

Root-canal piuggers



213-0065
Fig. 1
vertical condenser



213-0066
Fig. 2
vertical condenser



213-0067
Fig. 3
vertical condenser

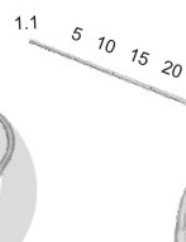

213-0068
Fig. 4
vertical condenser

FILLING INSTRUMENTS ●●●

Serrated

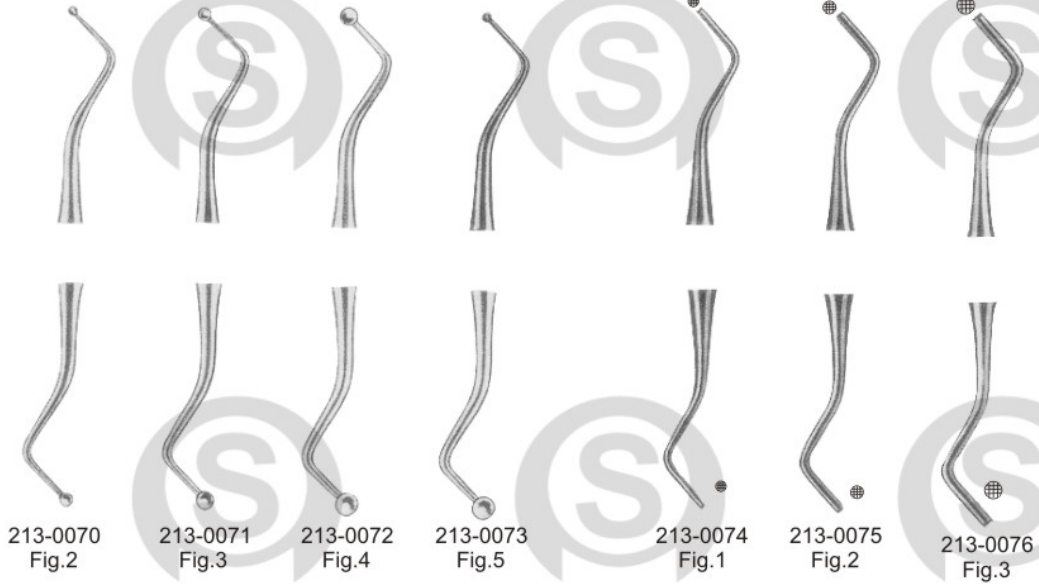

Smooth

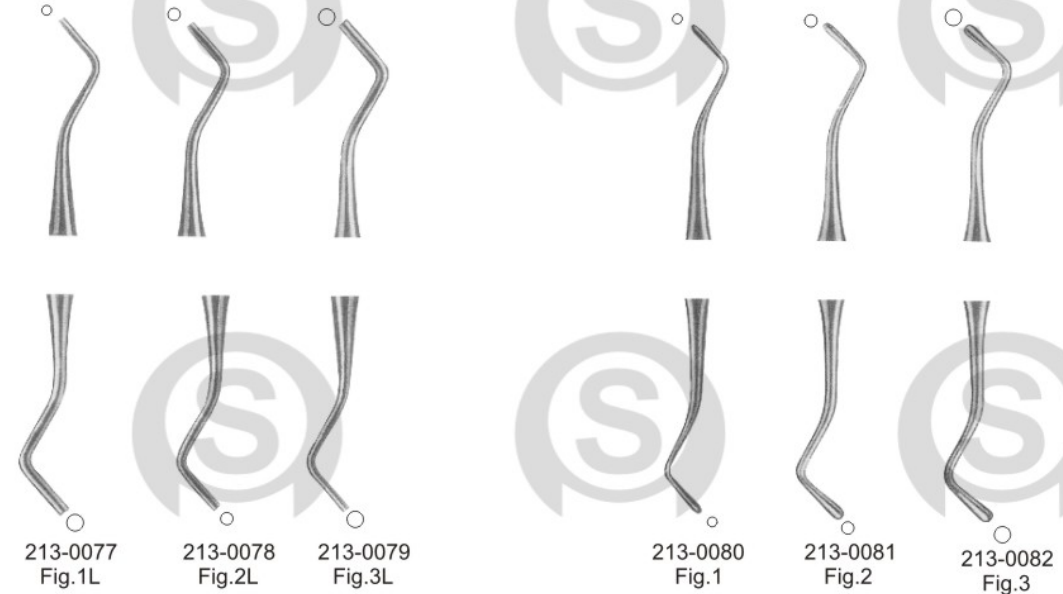



●●● **FILLING INSTRUMENTS**

ASTRO MEDICAL INSTRUMENTS

Serrated

Smooth

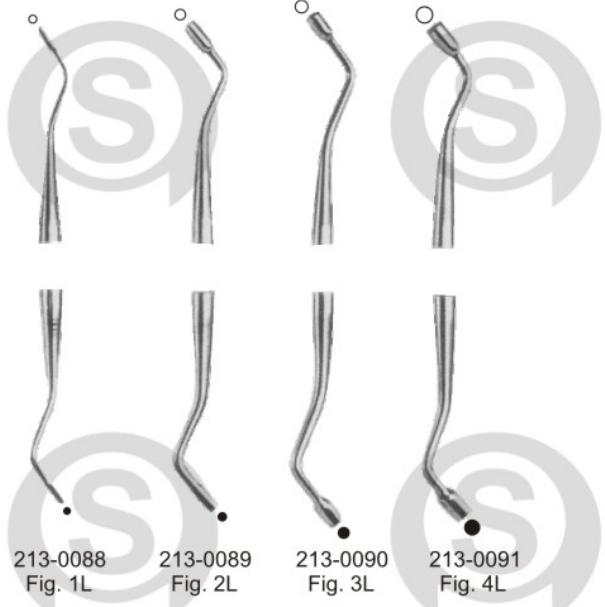
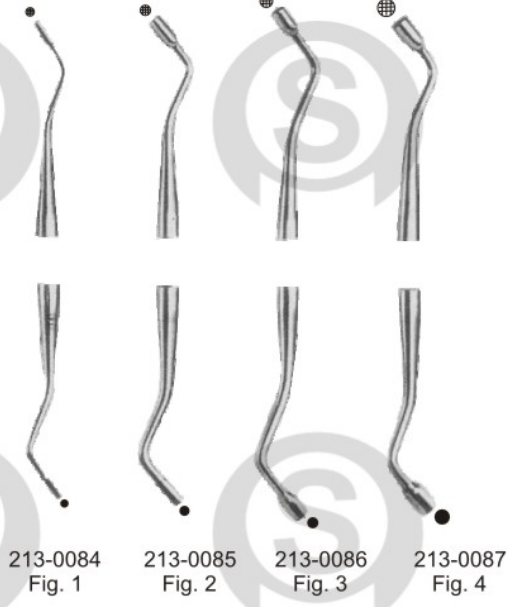

213-0083 Fig. 1

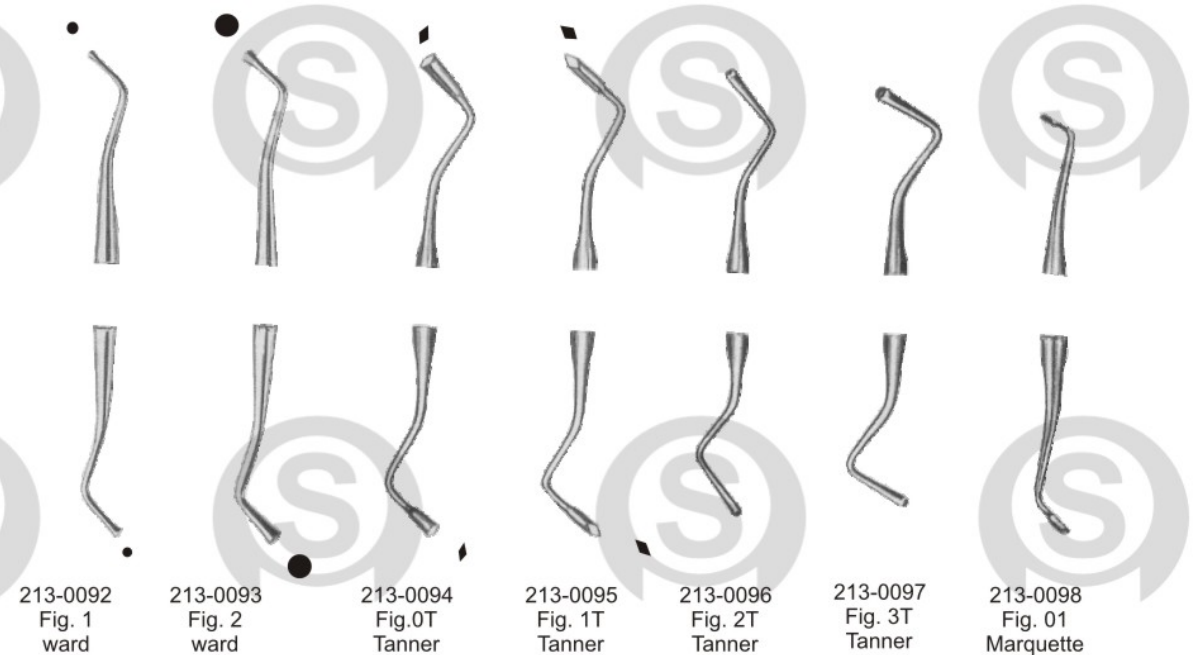

Serrated

FILLING INSTRUMENTS ●●●



213-0099
Fig. 1

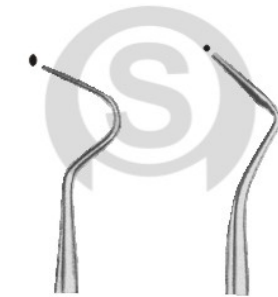

213-0100
Fig. 1

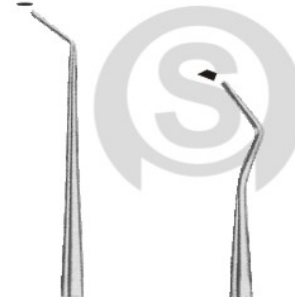

213-0101
Fig. 2

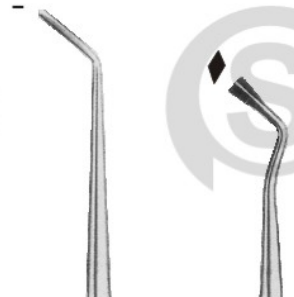

213-0102
Fig. 3



213-0103
Fig. 4

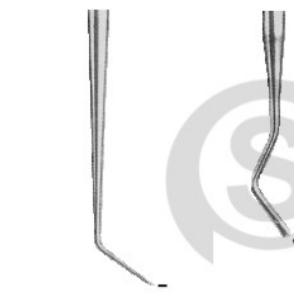

213-0104
Fig. 5



213-0105
Fig. 6

Set of 6 pieces



213-0106
Fig. H1
Hollenback

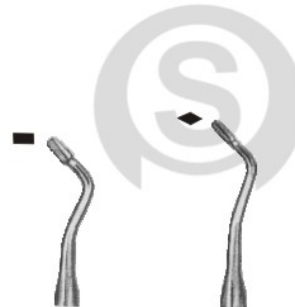

213-0107
Fig. H2
Hollenback



213-0108
Fig. H3
Hollenback



213-0109
Fig. H4
Hollenback



●●● **FILLING INSTRUMENTS** PLASTIC FILLING INSTRUMENTS

ASTRO MEDICAL INSTRUMENTS

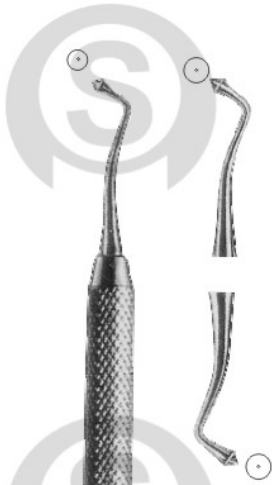

213-0111
Fig. 2
westcott



213-0112
Fig. 2
Ladmore



213-0113
Fig. 3
Ladmore



213-0114
Fig. 18
Ball

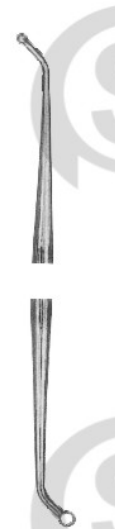

213-0115
Fig. 26-27S
Ball

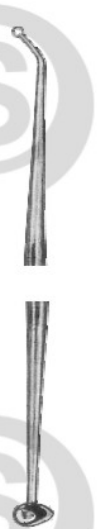

213-0116
Fig. 27-29
Ball



213-0117
Fig. NYU/B2

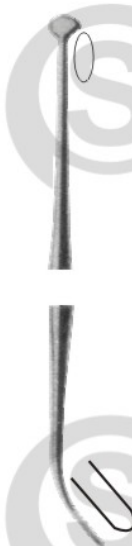

213-0118
Fig. 2/31



213-0110
Fig. 1
westcott

Plastic Filling Instruments



213-0119
Fig. 1



213-0120
Fig. 2



213-0121
Fig. 3



213-0122
Fig. 1



213-0123
Fig. 2



213-0124
Fig. 1



213-0125
Fig. 2

PLASTIC FILLING INSTRUMENTS AMALGAM CARVERS ●●●

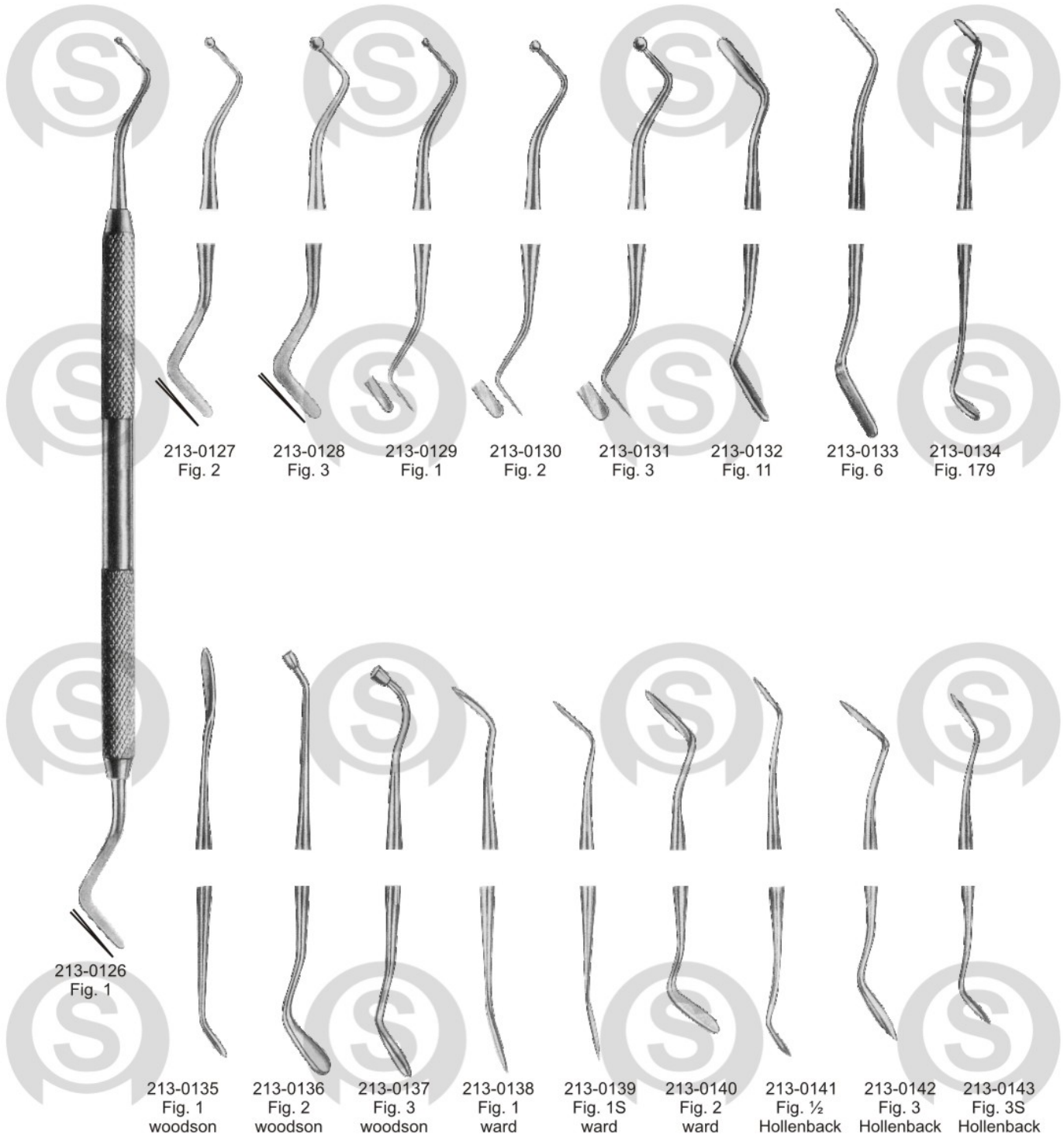



●●● **AMALGAM CARVERS** OPERATIVE INSTRUMENTS

ASTRO MEDICAL INSTRUMENTS



213-0144
Fig. 1
farhim

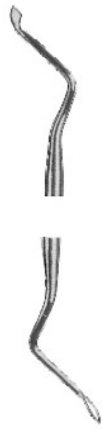

213-0145
Fig. 2
USC

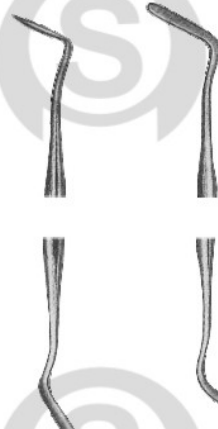

213-0146
Fig. 1
interproximal

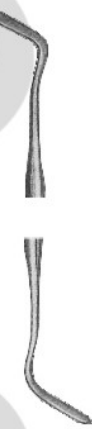

213-0147
Fig. 2
interproximal
Off-Angle



213-0148
Fig. SHO-A



213-0149
Fig. 3-SHO



213-0150
Fig. 104



213-0151
Fig. 8
wiland



213-0152
Fig. 1



213-0153
Fig. 2



213-0154
Fig. 3



213-0155
Fig. 4



213-0157



213-0158



213-0156

CAVITY PREPARATION INSTRUMENTS ●●●



213-0159
Fig. 1
Black/26

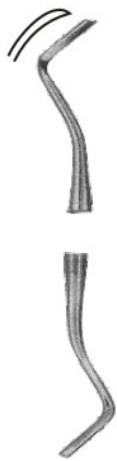

213-0160
Fig. 2
Black/27

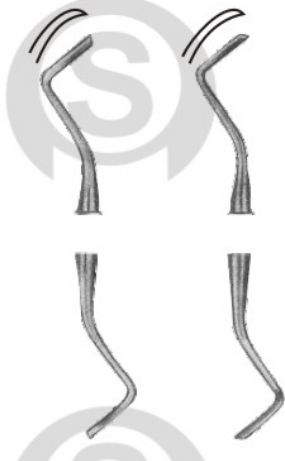

213-0161
Fig. 3
Black/28



213-0162
Fig. 4
Black/29

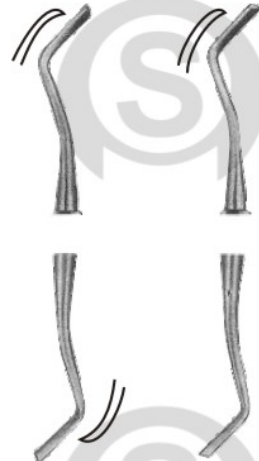

213-0163
Fig. 1
Black/77-78



213-0164
Fig. 2
Black/79-80



213-0165
Fig. 1
Black/53-54

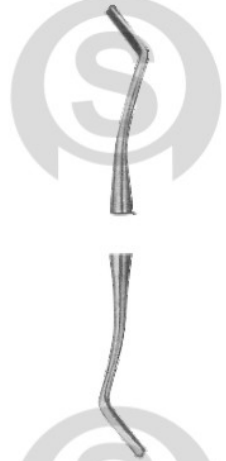

213-0166
Fig. 2
Black/51-52

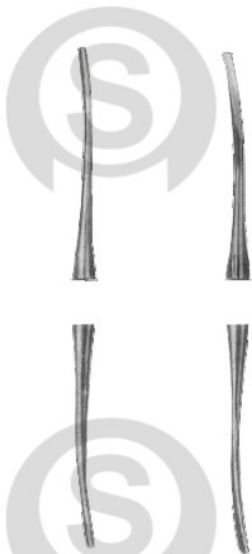

213-0167
Fig. 1/2
Wedelstaet



213-0168
Fig. 3/4
Wedelstaet



213-0169
Fig. 5/6
Wedelstaet

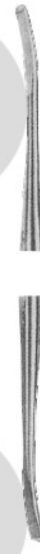

213-0170
Fig. 1/2
TG Chisel



213-0171
Fig. H6-H7
Hollow Handle

●●● EXCAVATORS

ASTRO MEDICAL INSTRUMENTS

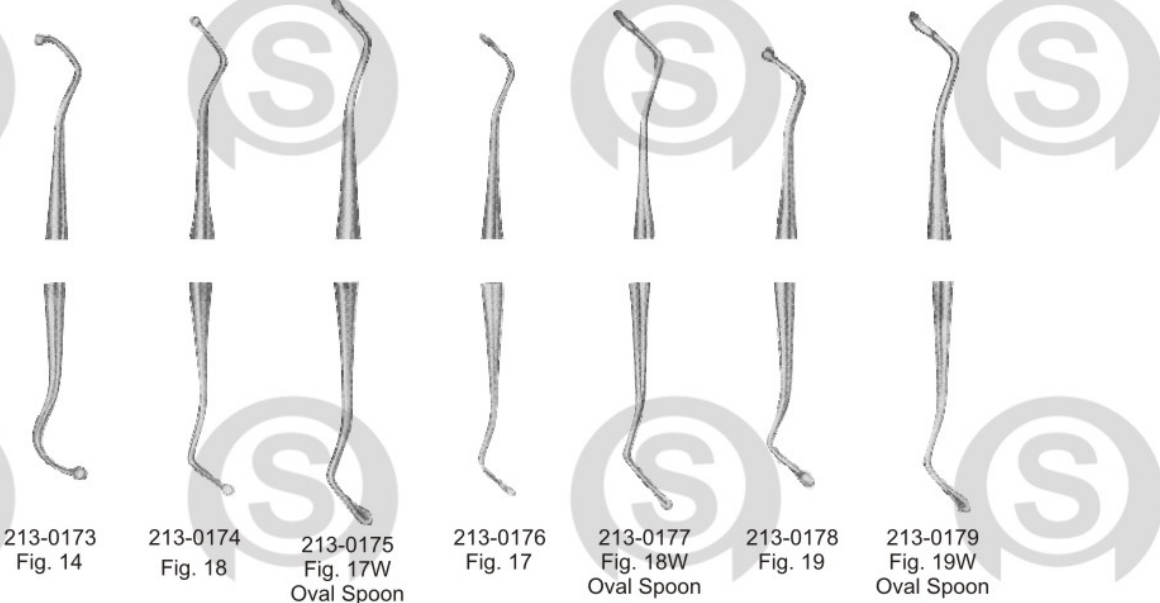

213-0173
Fig. 14

213-0174
Fig. 18

213-0175
Fig. 17W
Oval Spoon

213-0176
Fig. 17

213-0177
Fig. 18W
Oval Spoon

213-0178
Fig. 19

213-0179
Fig. 19W
Oval Spoon

213-0172
Fig. 6

Set of 5 Pieces

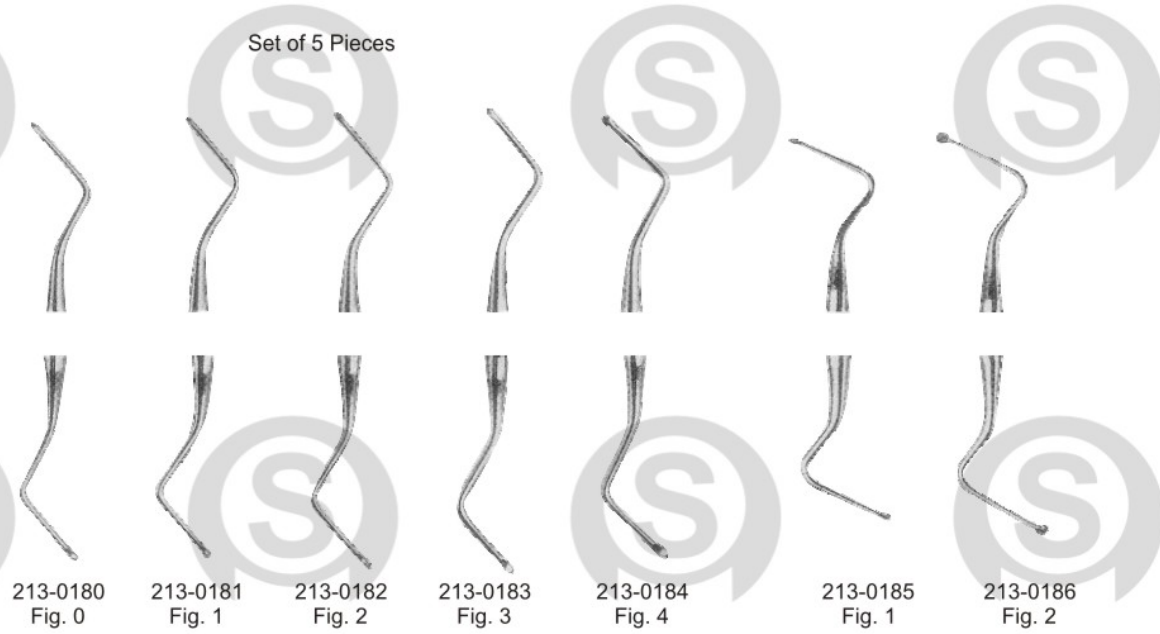

213-0180
Fig. 0

213-0181
Fig. 1

213-0182
Fig. 2

213-0183
Fig. 3

213-0184
Fig. 4

213-0185
Fig. 1

213-0186
Fig. 2

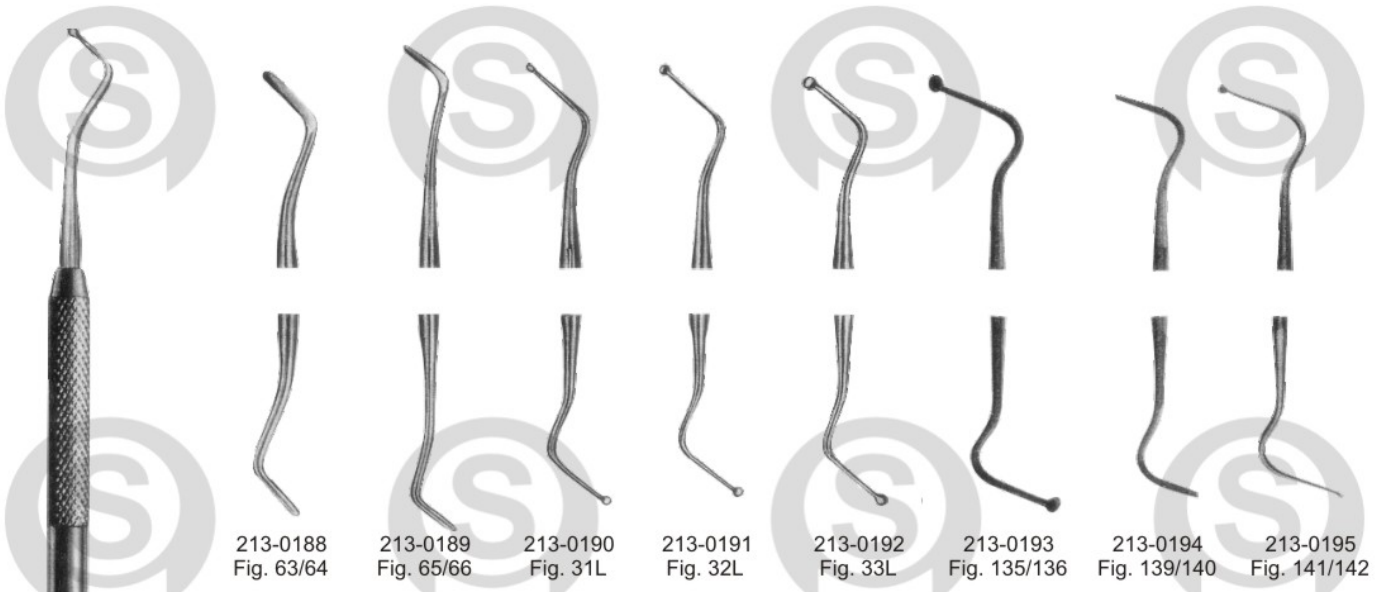

213-0188
Fig. 63/64

213-0189
Fig. 65/66

213-0190
Fig. 31L

213-0191
Fig. 32L

213-0192
Fig. 33L

213-0193
Fig. 135/136

213-0194
Fig. 139/140

213-0195
Fig. 141/142

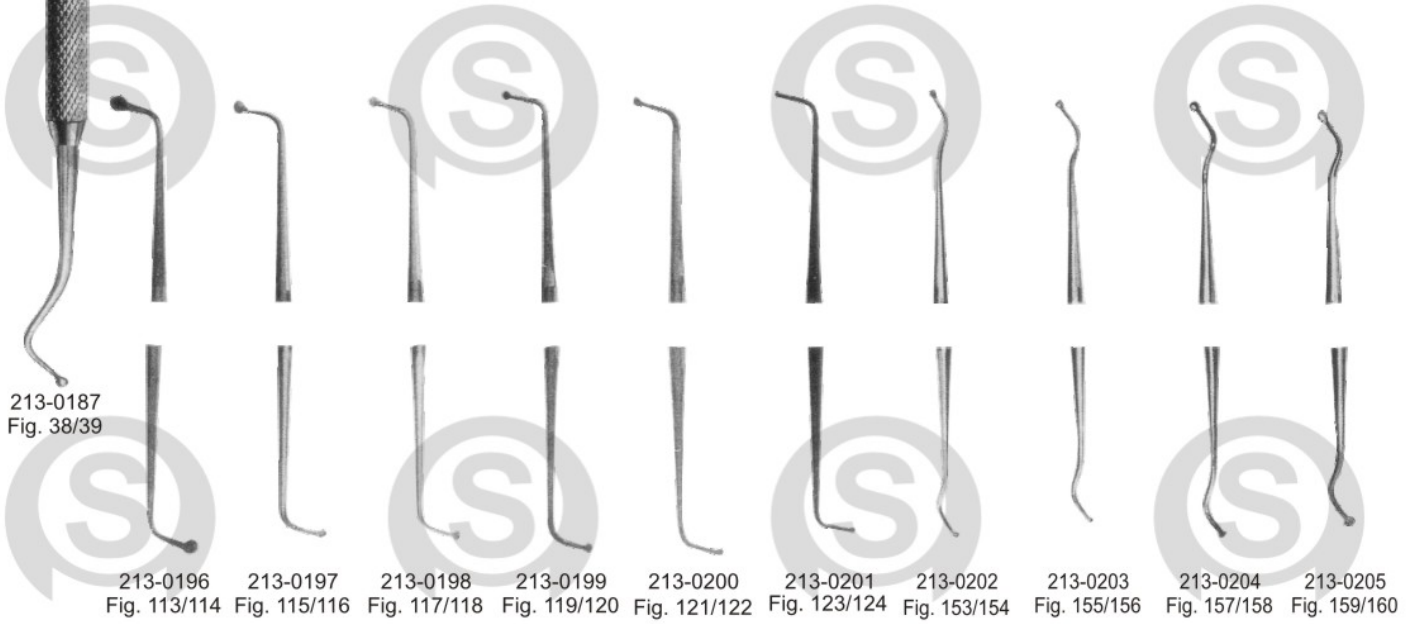

213-0187
Fig. 38/39

213-0196
Fig. 113/114

213-0197
Fig. 115/116

213-0198
Fig. 117/118

213-0199
Fig. 119/120

213-0200
Fig. 121/122

213-0201
Fig. 123/124

213-0202
Fig. 153/154

213-0203
Fig. 155/156

213-0204
Fig. 157/158

213-0205
Fig. 159/160



●●● **EXCAVATORS** ENGLISH PATTERN

ASTRO MEDICAL INSTRUMENTS

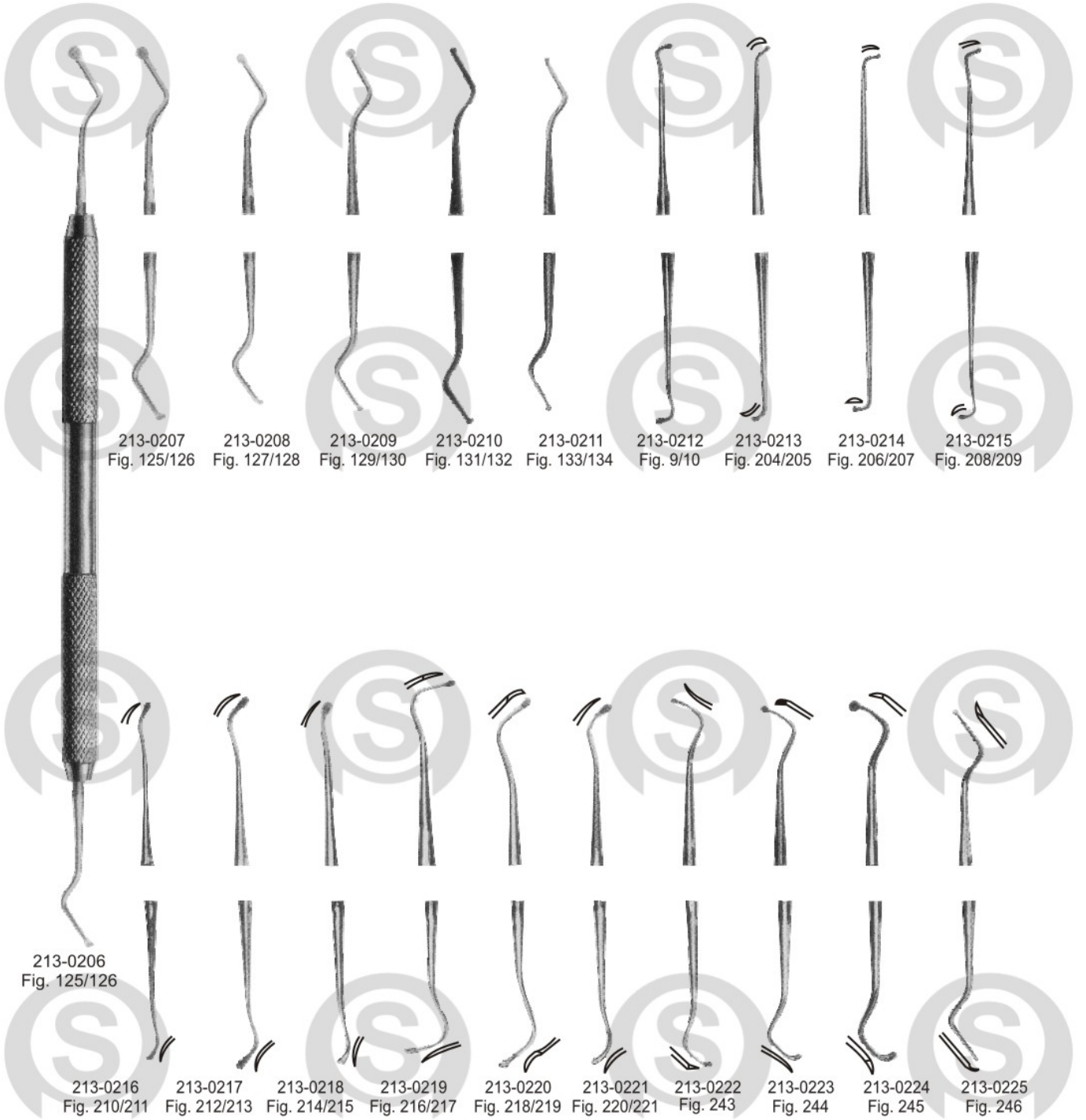



213-0226
Fig. M9
Molt

213-0227
Fig. 1
Hopkins

213-0228
Fig. 2
Hopkins

213-0229
Fig. 3
Mead

213-0230
Fig. 3
Prichard

213-0231
Fig. Pr3
Freer

213-0232
Fig. 16
Freer



BONE FILES

ASTRO MEDICAL INSTRUMENTS

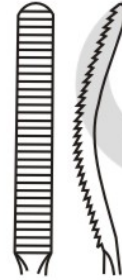
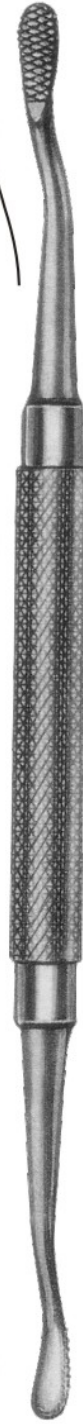

213-0233
Fig. 12 CA

213-0234
Fig. 12A

213-0235
Fig. 12
Howard

213-0236
Fig. 33

213-0237
Fig. 45
Miller



213-0238
Fig. 1
Wahl



213-0239
Fig. 2
Wahl

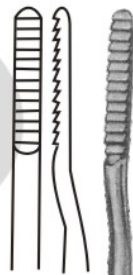

213-0240
Fig. 1
Polokoff



213-0241
Fig. 64
Miller

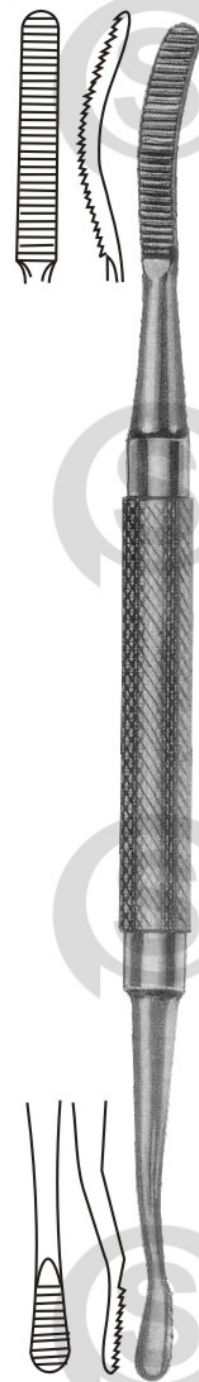

213-0242
Fig. 10

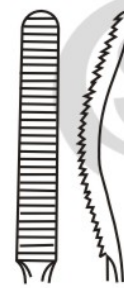



●●● **BONE CURETTES** PERIODONTIA INSTRUMENTS

ASTRO MEDICAL INSTRUMENTS



213-0243
Fig. 1
Hemingway

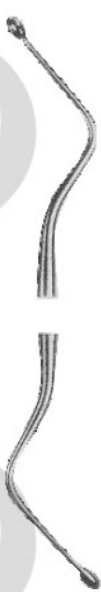

213-0244
Fig. 2
Hemingway

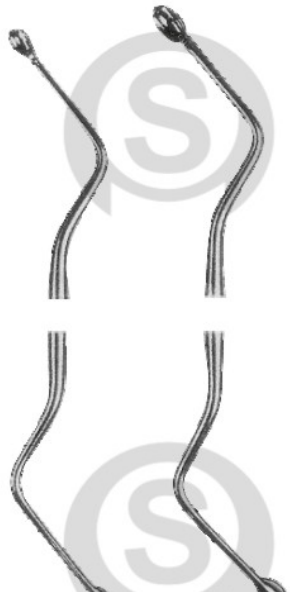

213-0245
Fig. 3
Hemingway



213-0246
Fig. 4
Hemingway



213-0247
Fig. 85
Lucas



213-0248
Fig. 86
Lucas



213-0249
Fig. 87
Lucas



213-0250
Fig. 88
Lucas



213-0251
Fig. 1S/2S
Sugarman

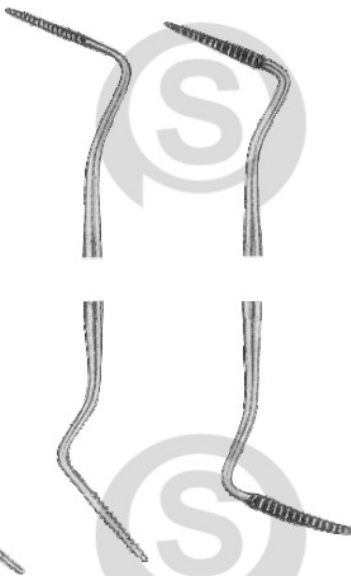

213-0252
Fig. 3S/4S
Sugarman



213-0254
Fig. 11/12
Buck



213-0255
Fig. 3
Ochsenbein

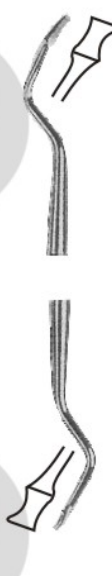

213-0256
Fig. 4
Ochsenbein



213-0257
Fig. 36/37
Rhodes back-action

PERIODONTIA INSTRUMENTS ●●●



213-0258
Fig. 7
Goldman-fox

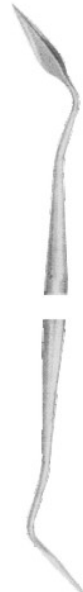

213-0259
Fig. 8
Goldman-fox

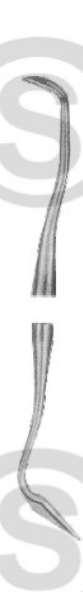

213-0260
Fig. 9
Goldman-fox

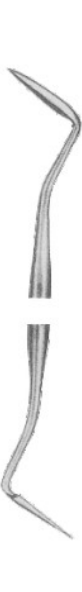

213-0261
Fig. 11
Goldman-fox

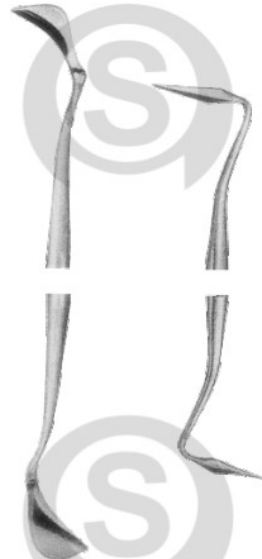

213-0262
Fig. 3/4
Buck

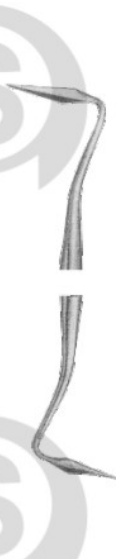

213-0263
Fig. 5/6
Buck



213-0264
Fig. 1/2
(15k16k)
Kirkland

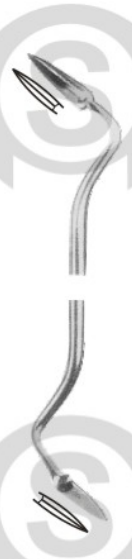

213-0265
Fig. 1/2
Orabin



213-0266
Fig. 1/2
Sanders



213-0267
Fig. 4/5
Sanders



213-0268
Fig. 19/20
Sanders
(University of South California)
USC Towner



213-0269
Fig. Ck3
crane-kaplan



●●● PERIODONTIA INSTRUMENTS

ASTRO MEDICAL INSTRUMENTS



213-0271
Fig. 2R/2L
columbia



213-0272
Fig. 4R/4L
columbia



213-0273
Fig. 13/14
columbia



213-0274
Fig. 414/412



213-0275
Fig. 413/414



213-0276
Fig. 1/2
Langer



213-0277
Fig. 3/4
Langer

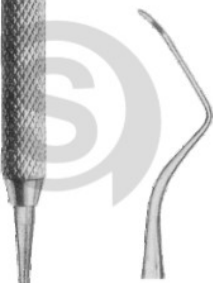

213-0270
Fig. HU 1/2
Curette



213-0278
Fig. 1/2
Barnhart



213-0279
Fig. 5/6
Barnhart



213-0280
Fig. ME-1
(10/11)



213-0281
Fig. 3/4
Rule(13/24)



213-0282
Fig. 11/14
Gracey
Mesial-Distal



213-0283
Fig. 12/13
Gracey
Mesial-Distal



213-0284
Fig. 13/14
Indiana University
Anterior



213-0285
Fig. 17/18
Indiana University
Posterior

PERIODONTIA INSTRUMENTS GRACEY CURETTES ●●●

Set of 9 Pieces
Set of 7 Pieces

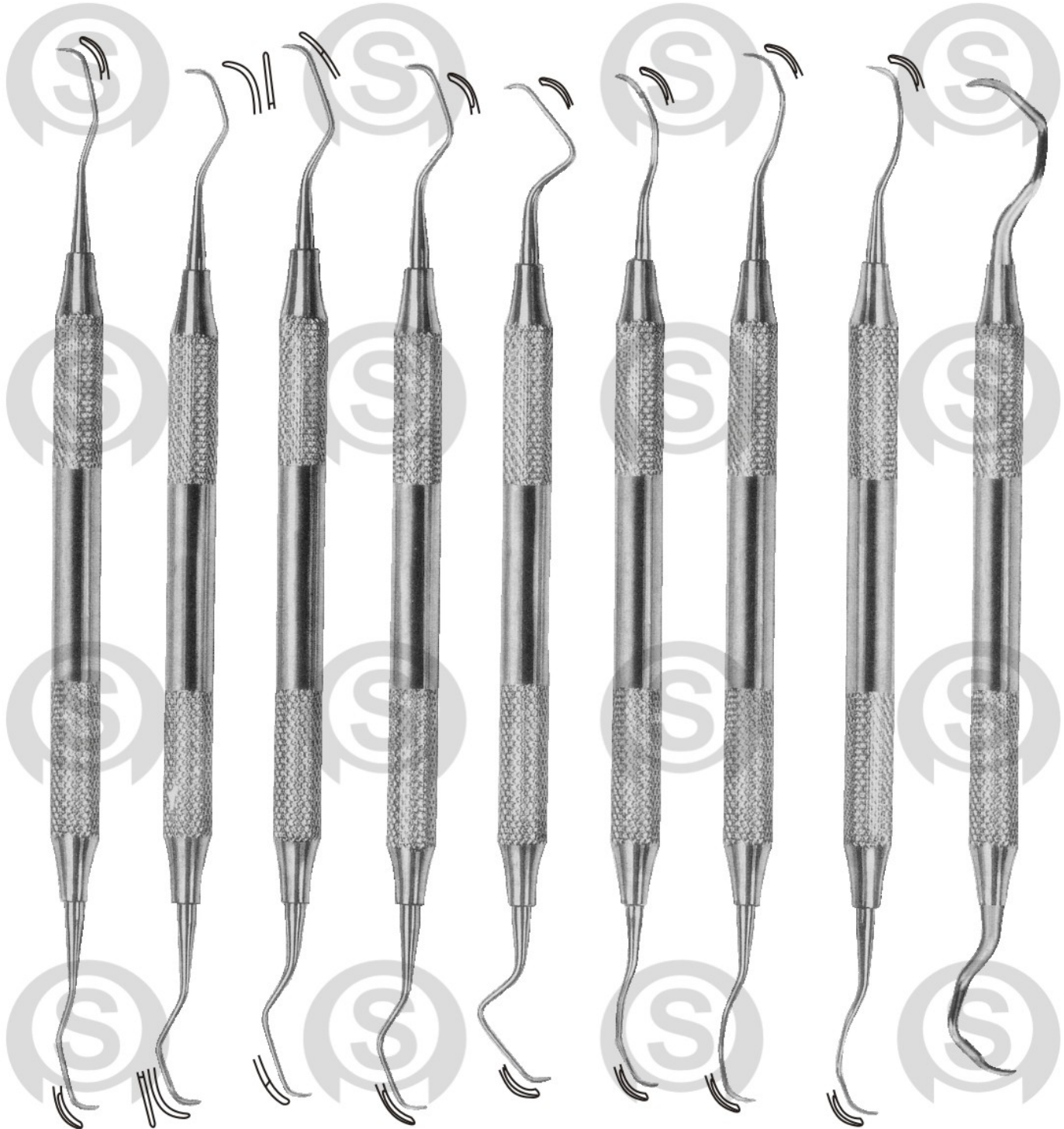

213-0286
Fig. 1/2
Gracey

213-0287
Fig. 3/4
Gracey

213-0288
Fig. 5/6
Gracey

213-0289
Fig. 7/8
Gracey

213-0290
Fig. 9/10
Gracey

213-0291
Fig. 11/12
Gracey

213-0292
Fig. 13/14
Gracey

213-0293
Fig. 15/16
Gracey

213-0294
Fig. 17/18
Gracey



●●● PERIODONTIA INSTRUMENTS

ASTRO MEDICAL INSTRUMENTS



213-0296
Fig. 1
Goldman-fox



213-0297
Fig. 2
Goldman-fox



213-0298
Fig. 3
Goldman-fox



213-0299
Fig. 4
Goldman-fox

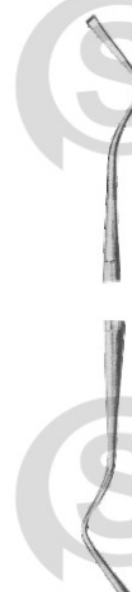

213-0300
Fig. 5
Goldman-fox



213-0301
Fig. 6
Goldman-fox



213-0302
Fig. 21
Goldman-fox



213-0295
Fig. 1
De Marco



213-0304
Fig. 11/12
Mc call

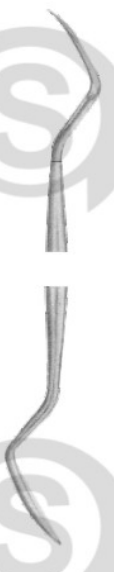

213-0305
Fig. 11A/12A
Mc call



213-0306
Fig. 13/14
Mc call

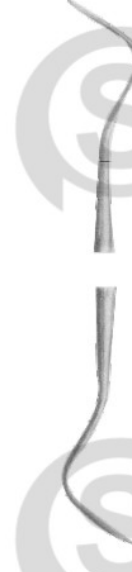

213-0307
Fig. 13S/14S
Mc call



213-0308
Fig. 17S/14S
Mc call



213-0309
Fig. 19/20
Mc call

213-0303
Fig. 2
De Marco

PERIODONTIA INSTRUMENTS

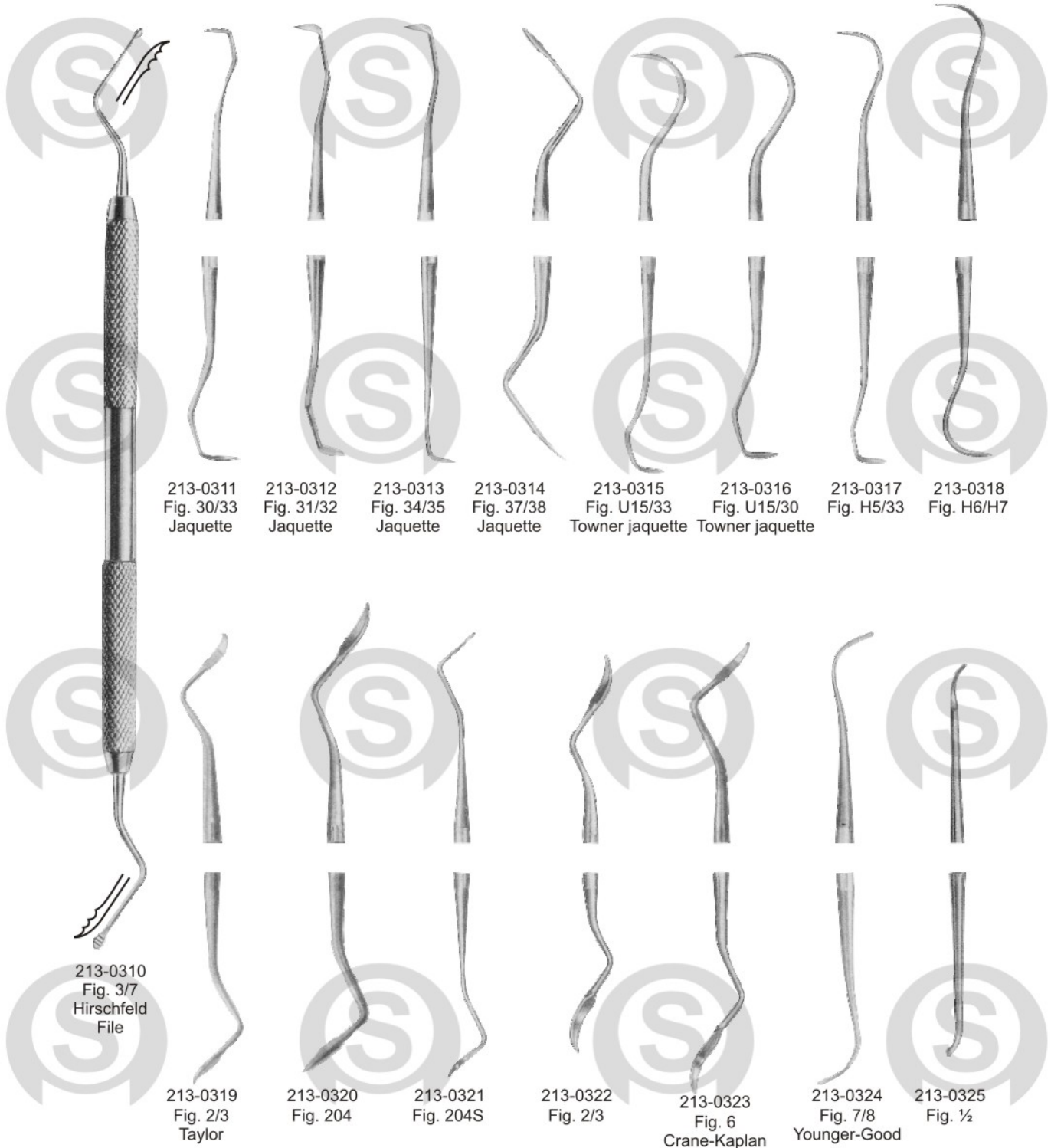



●●● PERIODONTIA INSTRUMENTS

ASTRO MEDICAL INSTRUMENTS



213-0327
Fig. 31



213-0328
Fig. 32



213-0329
Fig. 34



213-0330
Fig. 35



213-0331
Fig. H5
Hygienist



213-0332
Fig. H6
Hygienist



213-0333
Fig. H7
Hygienist



213-0326
Fig. 33



213-0334
Fig. 1

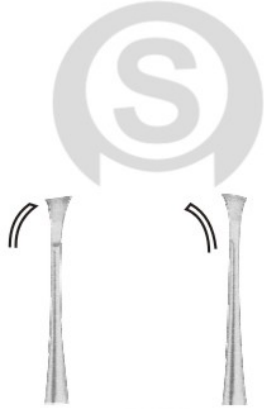

213-0335
Fig. 1L
(Sinistro)



213-0336
Fig. 1R
(Destro)



213-0337
Fig. 2L
(Sinistro)



213-0338
Fig. 2R
(Destro)



213-0339
Fig. U15
Towner



213-0340
Zetring-Chisel

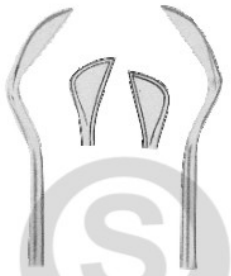

213-0341
Fig. 1
Kirkland



213-0342
Fig. 2
Kirkland



213-0343
Fig. 1
Orban



213-0344
Fig. 2
Orban



213-0345
Fig. 1
TG Chisel



213-0346
Fig. 2
TG Chisel

CEMENT SPATULAS



213-0347



213-0348



213-0349



213-0350



213-0351



213-0352



213-0353



213-0354



213-0355
Fig. 1



213-0356
Fig. 2



213-0357
Fig. 3



●●● WEX AND MODELLING CARVERS

ASTRO MEDICAL INSTRUMENTS



213-0358
Zahle

213-0359
Zahle



213-0360
Zahle

213-0361
Hylin



213-0362
Hylin-Ceramica



213-0363
Hylin-Sacred



213-0364
Hylin-Le Cron



213-0365
Sacred

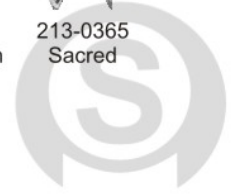
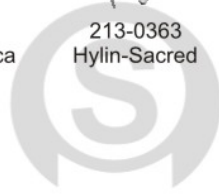

WEX AND MODELLING CARVERS ●●●



213-0366
Le Cron

213-0367
Le Cron

213-0368
Vehe

213-0369
Beale

213-0370
Roach

213-0371
Le cron

213-0372
Le cron

213-0373
Gritman



●●● WEX AND MODELLING CARVERS

ASTRO MEDICAL INSTRUMENTS



213-0374
Fig. 1
P. K.thomas



213-0375
Fig. 2
P. K.thomas



213-0376
Fig. 3
P. K.thomas



213-0377
Fig. 4
P. K.thomas

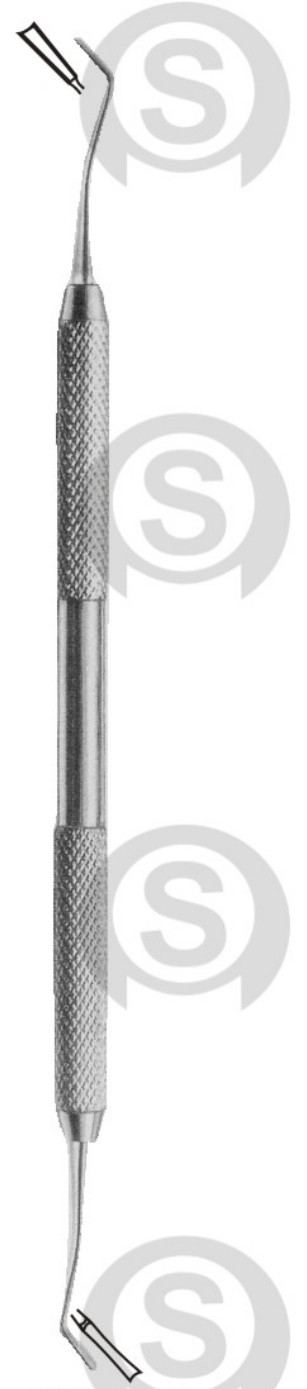

213-0378
Fig. 5
P. K.thomas



214-0001
Fig. 1
Fahnenstock
12.5 cm

214-0002
Fig. 1
Lessmann
12.5 cm

214-0003
Fig. 1
Con Scodelina

214-0004
Fig. 2
Fehnenstock

214-0005
Fig. 2
Lessmann

214-0006
Fig. 2
Con Scodelina



●●● SPATULAS FOR PLASTER AND ALGINATE

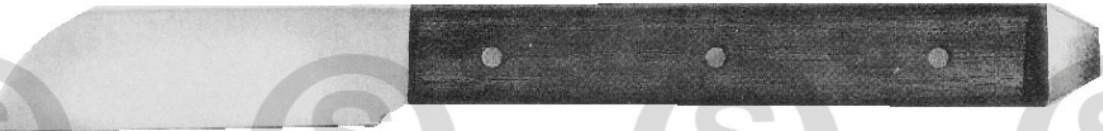

214-0007
cm 17

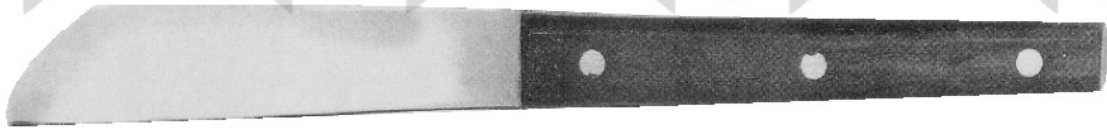

214-0008
cm 17 Gritman



214-0009
cm 19.5

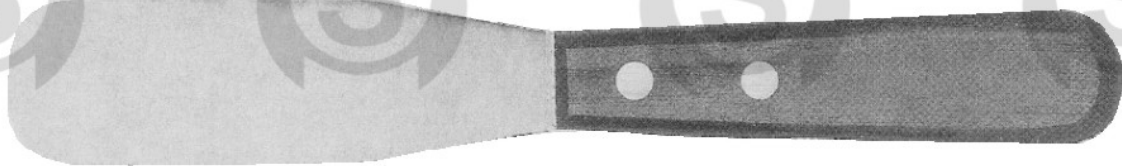

214-0010
cm 21.5

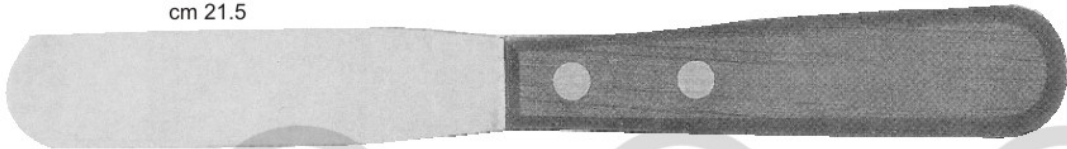

214-0011
cm 20.5

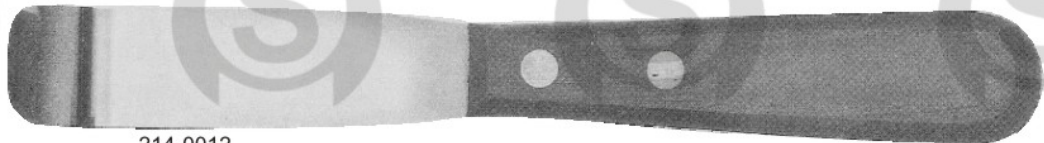

214-0012
cm 19.5

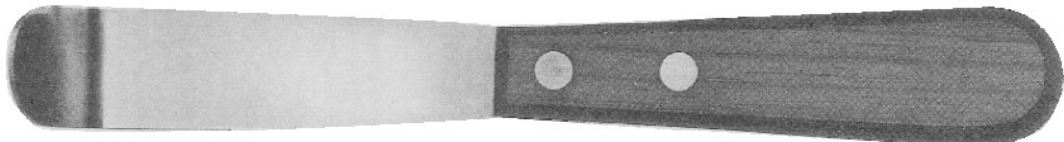

214-0013
cm 20

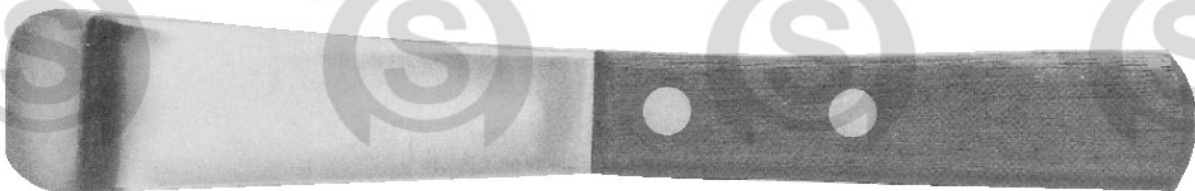

214-0014
cm 22.5

AMALGAM CARRIERS ●●●

Ø1.5 mm



215-0001
Small

Ø2 mm



215-0002
Medium

Ø2.5 mm



215-0003
Large

Ø3 mm



215-0004
Jumbo



215-0005
Jumbo
Amalgam Well

Ø2 mm

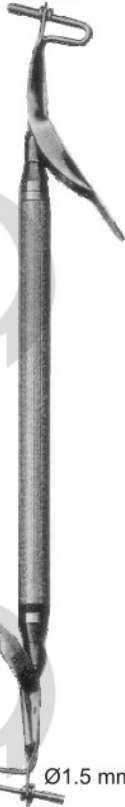

215-0006
Medium Small

Ø2 mm



215-0007
Medium Large

Ø2 mm



215-0008
Medium Jumbo

Ø1.5 mm



215-0009

Ø2.5 mm



215-0010

Ø3 mm



215-0011



●●● DENTAL CARTRIDGE SYRINGES

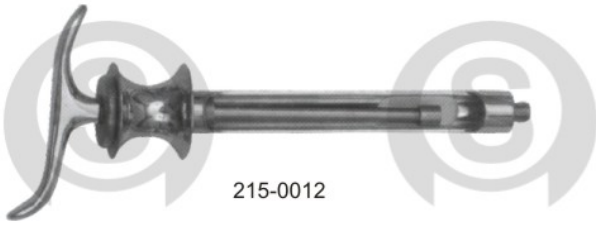

215-0012

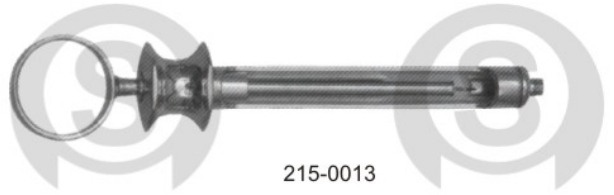

215-0013



215-0014

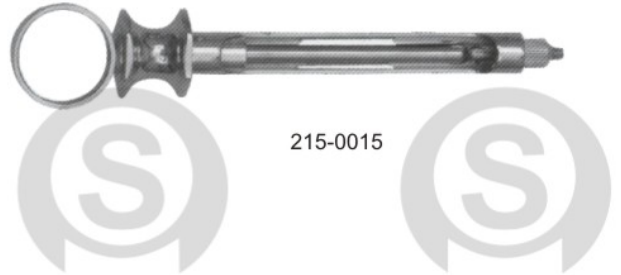

215-0015



215-0016



215-0017



215-0018



215-0019

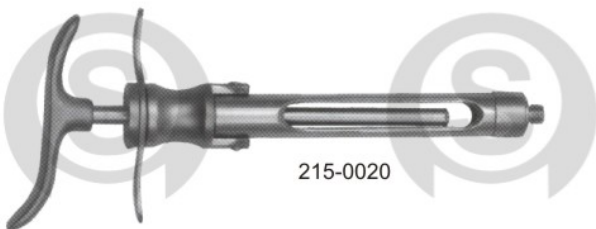

215-0020

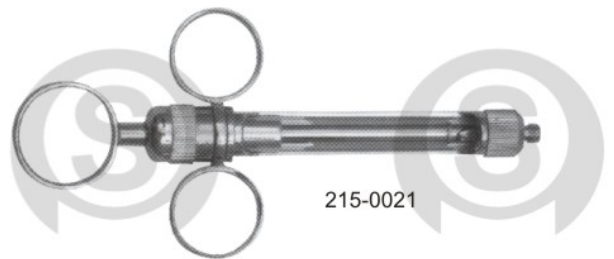

215-0021

ASTRO MEDICAL INSTRUMENTS

DENTAL CARTRIDGE SYRINGES ●●●



215-0022



215-0023

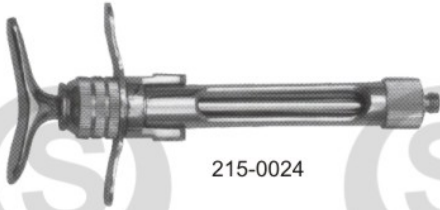

215-0024



215-0025

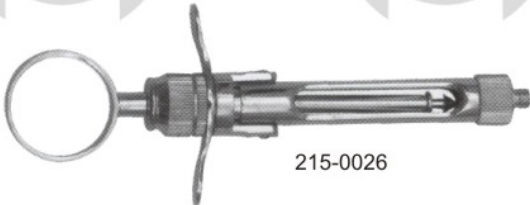

215-0026



215-0027



215-0028

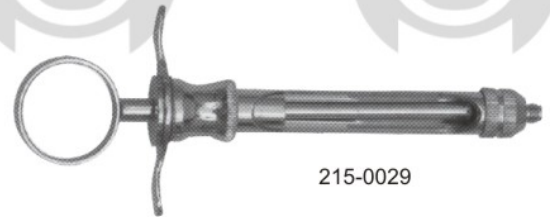

215-0029

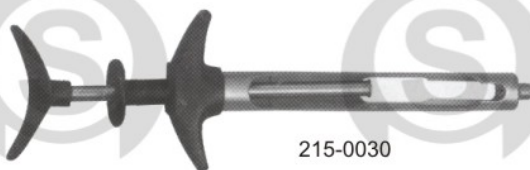

215-0030



215-0031



●●● CHIP BLOWERS, WATER SYRINGES



Chip bolwer



215-0032

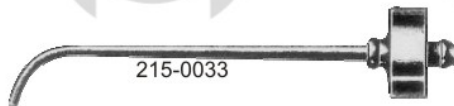

215-0033

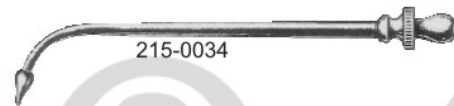

215-0034

Films Holder

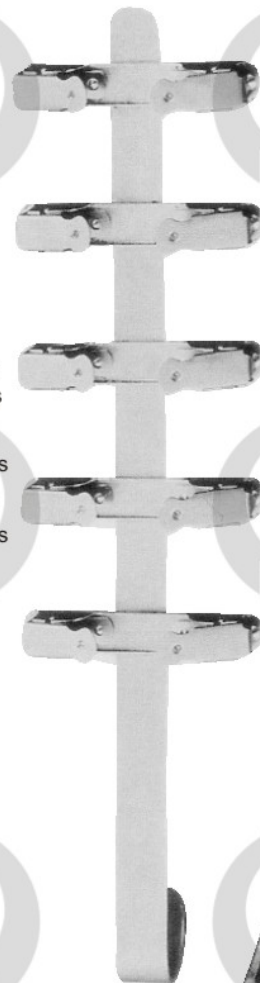

215-0035
For 6 Films

215-0036
For 10 Films

215-0037
For 14 Films



215-0038
Water Syringe

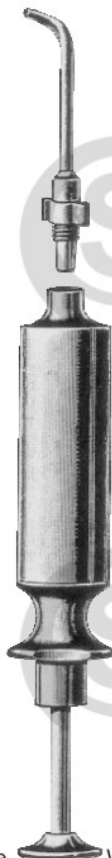

215-0039
Water Syringe



215-0040
Napkin holder with plastic band

215-0041
Napkin holder with metal chain

ASTRO MEDICAL INSTRUMENTS

MATRIX RETAINERS ●●●



215-0042-5mm
215-0043-6mm
215-0044-7mm
Ivory



215-0045
Ivory 8 N



215-0046
Ivory 8



215-0047
Siqveland-narrow
215-0048
Siqveland-wide



215-0049
Fig. 1
Toffemire-universal



215-0050
Fig. 2
Toffemire-senior



215-0051
Fig. 3
Toffemire-junior



215-0052
Fig. 2
Didher 8



215-0053
Ivory



215-0054
Ivory



215-0055
Ivory separator



●●● **CROWN INSTRUMENTS**

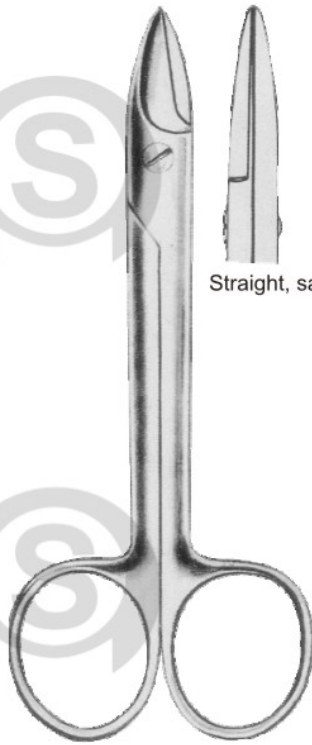

Straight, saw edge

215-0056
Fig.1
10.5cm

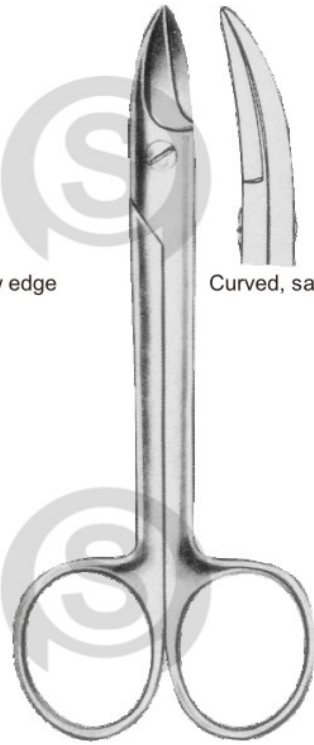

Curved, saw edge

215-0057
Fig.2
10.5cm

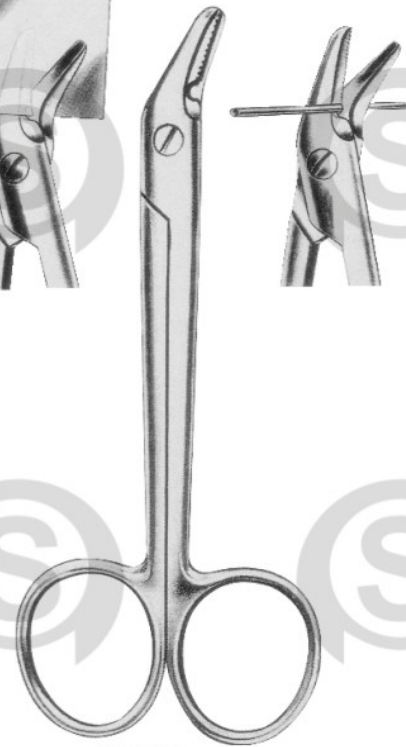

215-0058
Universal
12cm



215-0059
Lwanson



Universal

215-0060
Fig.3
Crown spreaders



215-0061
Boley
14cm

ASTRO MEDICAL INSTRUMENTS

CROWN REMOVERS ●●●

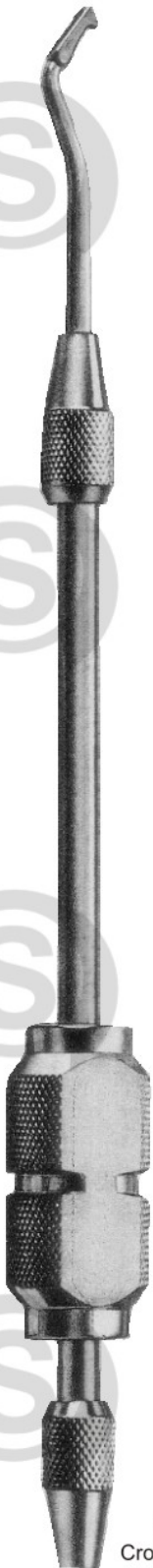

215-0063
Crown removers
Without Spring

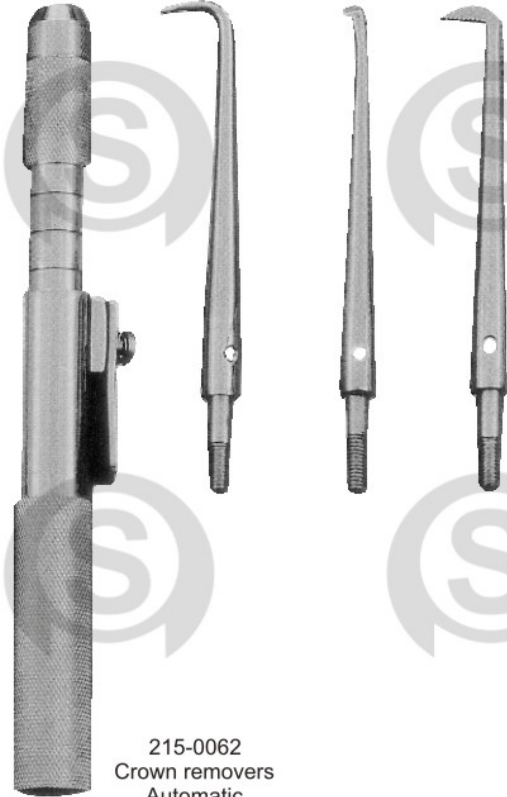

215-0062
Crown removers
Automatic



215-0064
Crown removers
With Spring



With 5 Points

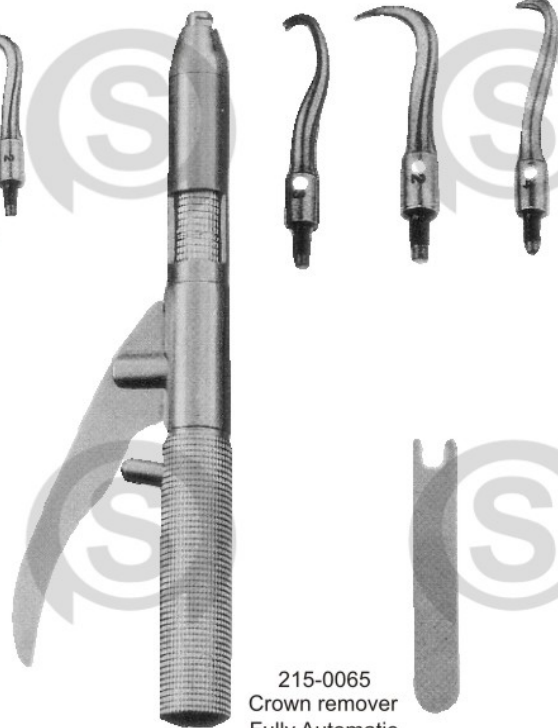

215-0065
Crown remover
Fully Automatic



●●● CROWN INSTRUMENTS



215-0066
Articulating Paper Forcep
15cm



215-0067
Miller
15cm



215-0068
Crown Spreader



215-0069
Vernier Gauge Caliper
0mm to 80mm

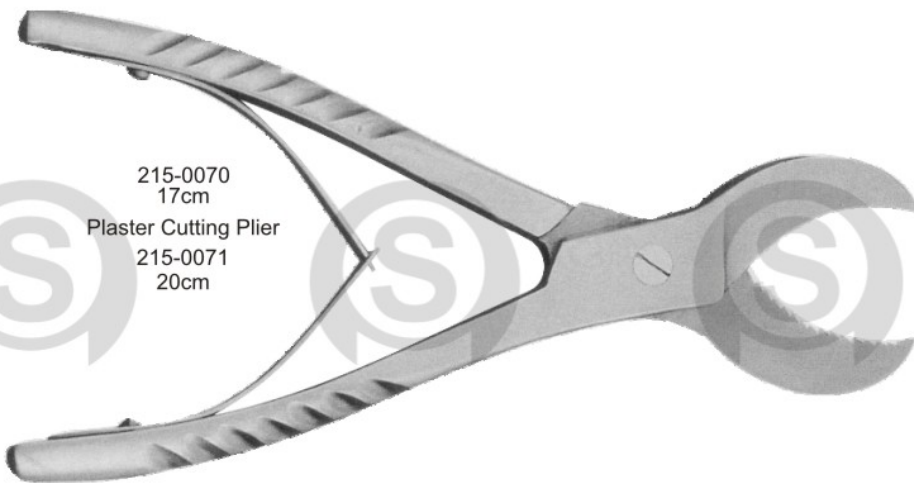

215-0070
17cm
Plaster Cutting Plier
215-0071
20cm



215-0072
Arch Turret with 5 wire-slots
.016", .017", .018", .020" and .022"

ASTRO MEDICAL INSTRUMENTS

IMPRESSION TRAYS ●●●

Available in Set of 8
Code # Set - A001

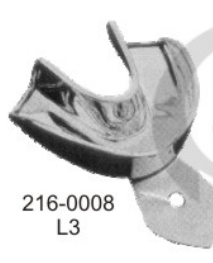
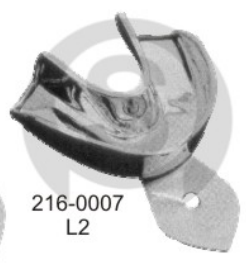
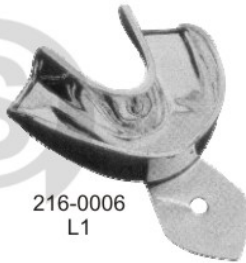
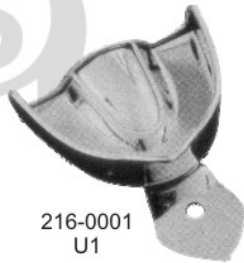

All the above impression trays are available in these 4 sizes

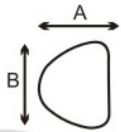

UPPER		U1	U2	U3	U4	U5
	A	62	60	53	54	52
B	63	75	73	69	68	

All Dimension are in mm

Lower		L1	L2	L3	L4	L5
	A	63	61	57	60	53
B	82	81	78	74	71	

All Dimension are in mm

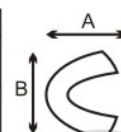

Available in Set of 8
Code # Set - A002



●●● IMPRESSION TRAYS

Available in Set of 8
Code # Set - A003

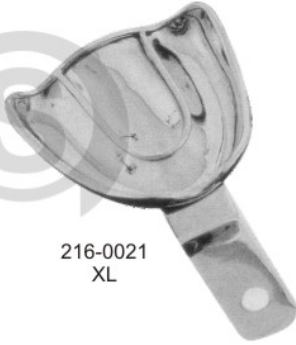

216-0021
XL



216-0022
L



216-0023
M



216-0024
S



216-0025
XL



216-0026
L

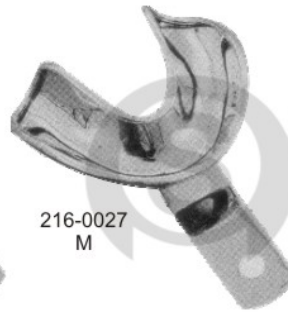

216-0027
M

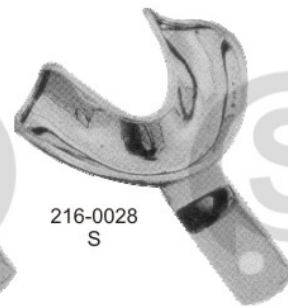

216-0028
S

All the above impression trays are available in these 4 sizes

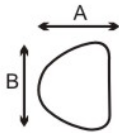

UPPER	XL	L	M	S
	A	70	67	64
B	79	78	70	73

All Dimension are in mm

LOWER	XL	L	M	S
	A	64	64	60
B	86	70	73	70

All Dimension are in mm

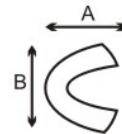

216-0029
XL

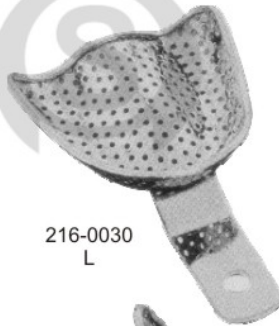

216-0030
L

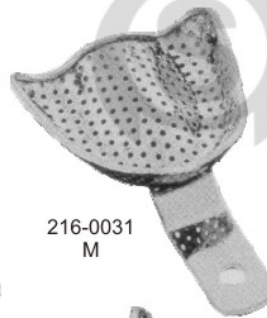

216-0031
M

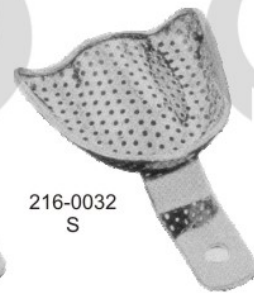

216-0032
S



216-0033
XL



216-0034
L



216-0035
M

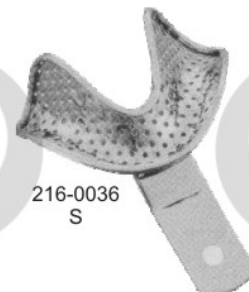

216-0036
S

Available in Set of 8
Code # Set - A004

ASTRO MEDICAL INSTRUMENTS

IMPRESSION TRAYS ●●●

Available in Set of 6
Code # Set - A005

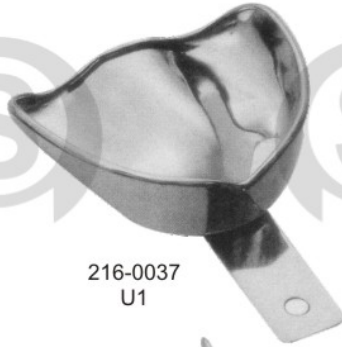

216-0037
U1



216-0038
U2

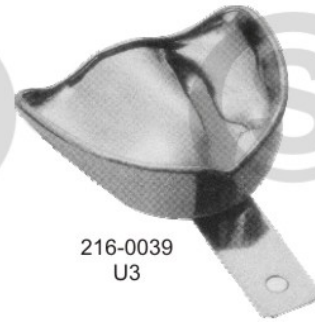

216-0039
U3

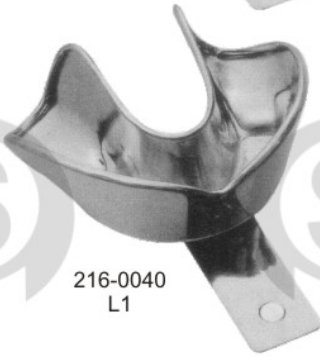

216-0040
L1



216-0041
L2

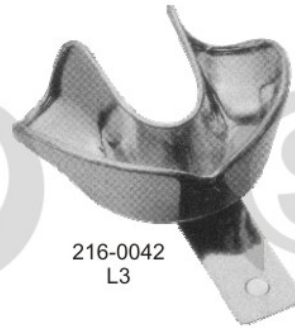

216-0042
L3

All the above impression trays are available in these 4 sizes

LOWER	All Dimension are in mm		
	L1	L2	L3
A	67	64	57
B	81	71	70

LOWER	All Dimension are in mm		
	L1	L2	L3
A	60	57	64
B	84	79	76



216-0043
U1



216-0044
U2



216-0045
U3



216-0046
L1



216-0047
L2



216-0048
L3

Available in Set of 6
Code # Set - A006



●●● IMPRESSION TRAYS

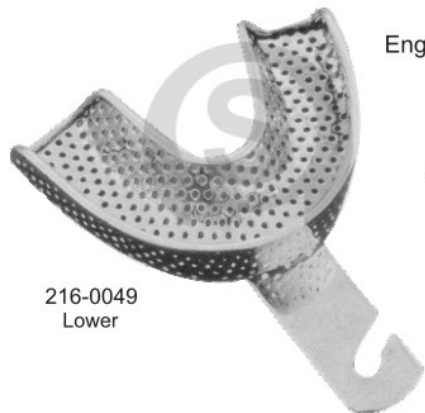

216-0049
Lower

English Pattern

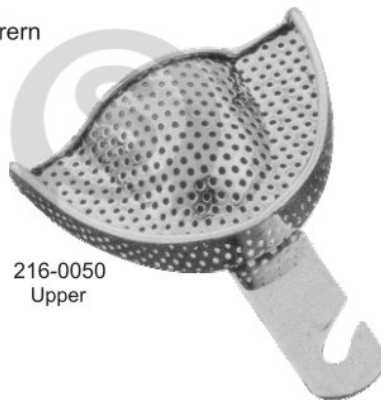

216-0050
Upper

Mesh type

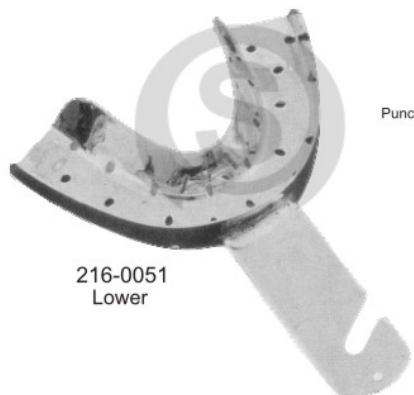

216-0051
Lower

Punched Type

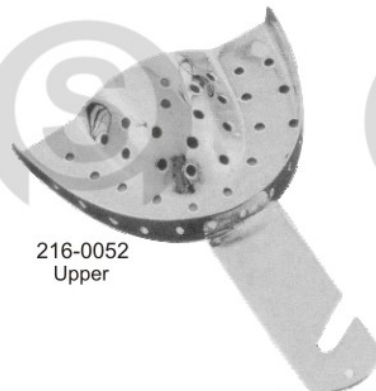

216-0052
Upper

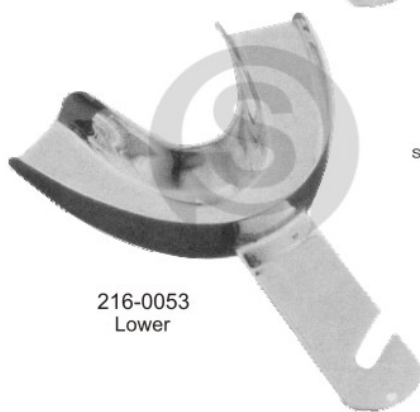

216-0053
Lower

Solid Type



216-0054
Upper

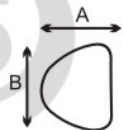

All the above impression trays are available in these 4 sizes

UPPER	Size	A	B	C
	0	67	50	12
	1	72	51	13
	2	78	55	15
	3	80	58	15

All Dimension are in mm

LOWER	Size	A	B	C
	0	70	50	12
	1	77	51	13
	2	77	55	15
	3	80	50	15

All Dimension are in mm

IMPRESSION TRAYS ●●●

Available in Set of 8
Code # Set - A007

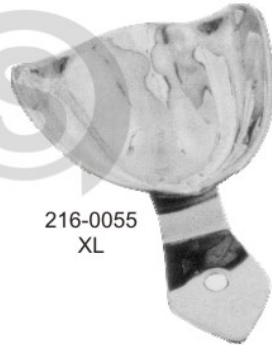

216-0055
XL

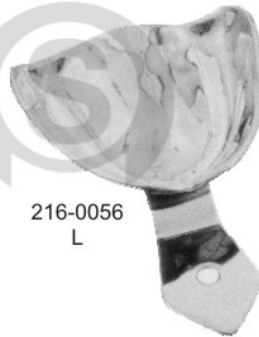

216-0056
L

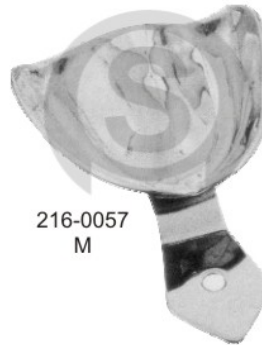

216-0057
M

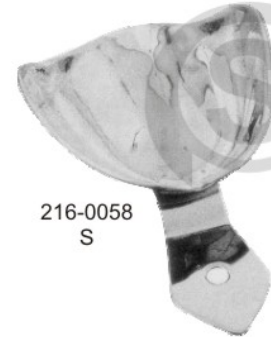

216-0058
S

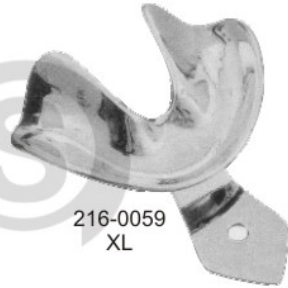

216-0059
XL



216-0060
L

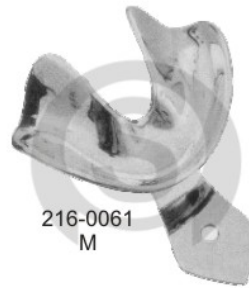

216-0061
M

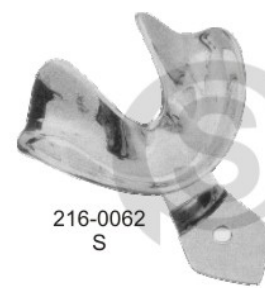

216-0062
S

All the above impression trays are available in these 4 sizes

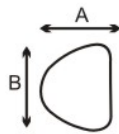

UPPER		XL	L	M	S
	A	70	67	64	60
B	79	78	70	73	

All Dimension are in mm

LOWER		XL	L	M	S
	A	64	64	60	57
B	86	70	73	70	

All Dimension are in mm

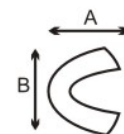

216-0063
XL



216-0064
L



216-0065
M

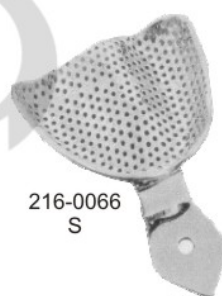

216-0066
S

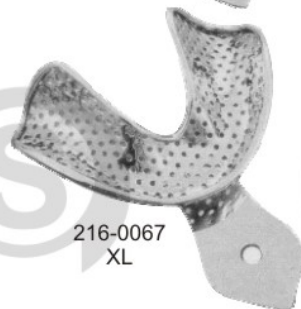

216-0067
XL

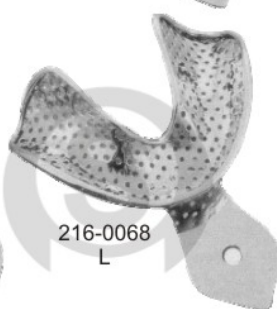

216-0068
L

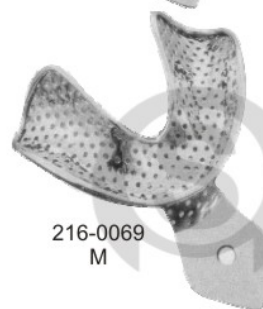

216-0069
M

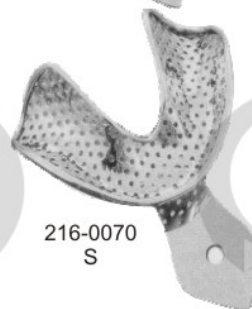

216-0070
S

Available in Set of 8
Code # Set - A008



●●● IMPRESSION TRAYS

Available in Set of 8
Code # Set - A009

For crown & bridgework Impression Trays



216-0071
U0



216-0072
U1



216-0073
U2



216-0074
U3

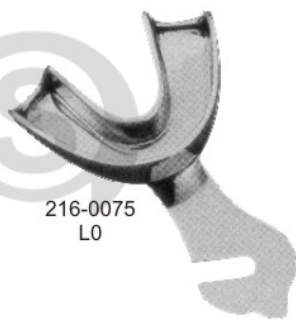

216-0075
L0



216-0076
L1

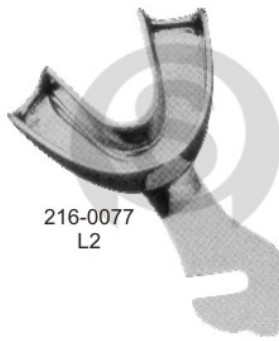

216-0077
L2

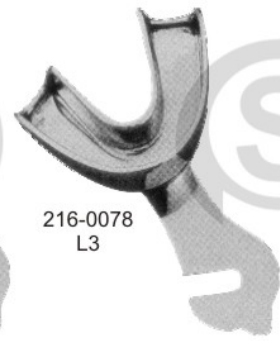

216-0078
L3

Upper Sizes 0,1,2,3,
Depth of the tray 19,9 mm
Height of palate 12,5 mm

Lower Sizes 0,1,2,3,
Depth of the tray 12,9 mm

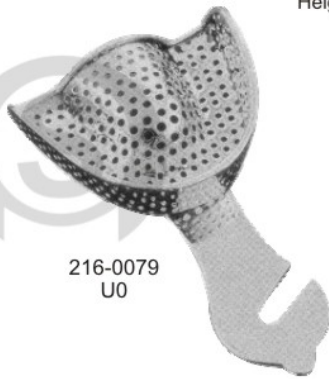

216-0079
U0

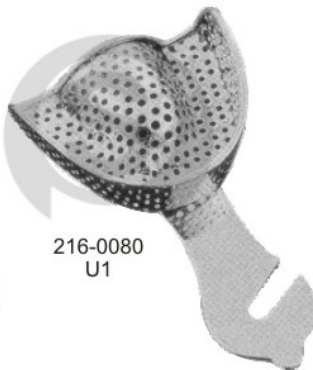

216-0080
U1



216-0081
U2



216-0082
U3



216-0083
L0



216-0084
L1

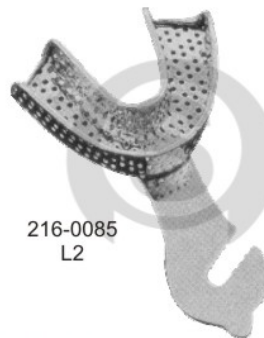

216-0085
L2

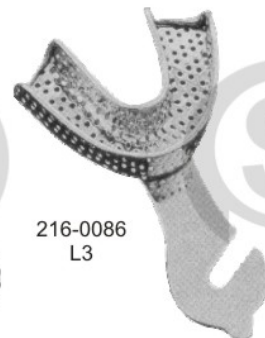

216-0086
L3

Available in Set of 8
Code # Set - A010

IMPRESSION TRAYS ●●●

Impression trays for crown & bridge work



216-0087
U1P



Solid
216-0088
L1P



216-0089
U1P



Perforated
216-0090
L1P



216-0091
For upper right jaw
For lower left jaw

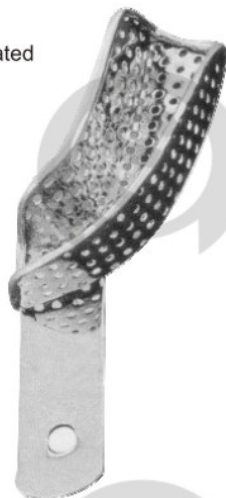

216-0092
For upper left jaw
For lower right jaw

Available in 4 Sizes
1.....44 mm
2.....55 mm
3.....60 mm
4.....65 mm

Also available in Solid pattern



216-0093
Adjustable
Perforated

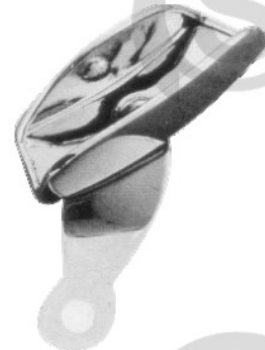

216-0094
Adjustable
Solid



●●● INSTRUMENTS TRAYS

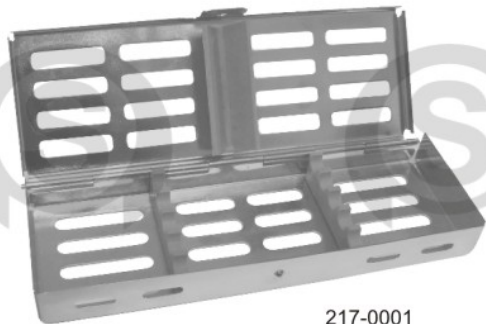

217-0001
Scaler Sterilizing Tray
For 5-pcs
18 x 6 x 2 cm



217-0002
Scaler Sterilizing Tray
For 5-pcs
18 x 8.5 x 2 cm



217-0003
Scaler Sterilizing Tray
For 10-pcs
18 x 12.5 x 2 cm



217-0004
Scaler Sterilizing Tray
For 10-pcs
18 x 14 x 2 cm

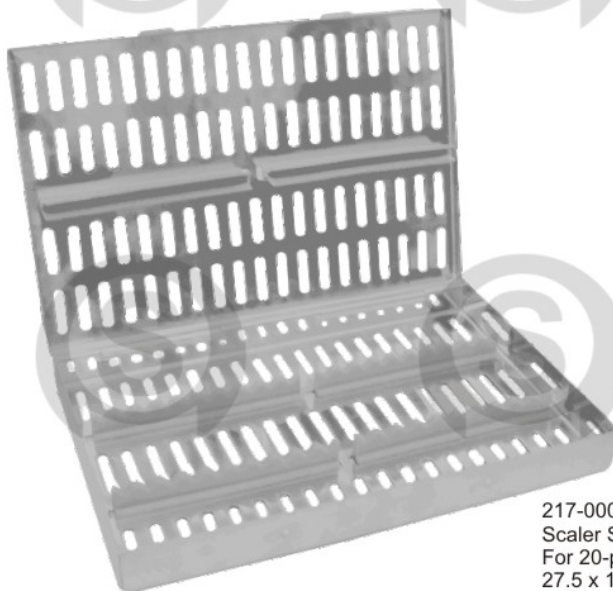

217-0005
Scaler Sterilizing Tray
For 20-pcs
27.5 x 18 x 2.5 cm

HOLLOW WARE ITEMS ●●●

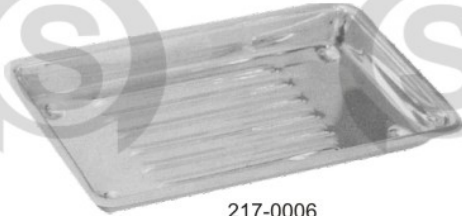

217-0006
Scallers Tray



Instruments Box

- 217-0007
10"×6"×2"
- 217-0008
12"×8"×2½"
- 217-0009
16"×12"×4"

- 217-0010
8"×6"×2"
- 217-0011
10"×8"×2"
- 217-0012
12"×8"×2½"
- 217-0013
12"×10"×2½"
- 217-0014
14"×10"×2½"
- 217-0015
14"×12"×2½"



Instruments Tray with Lid

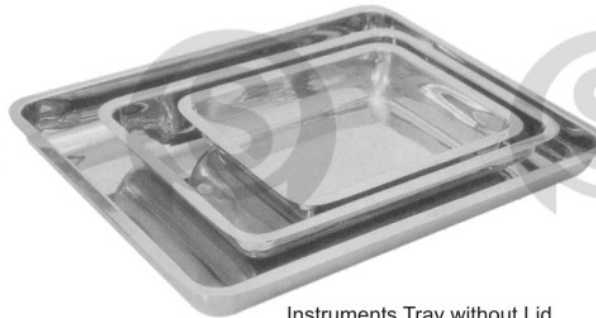

Instruments Tray without Lid

- 217-0016
8"×6"×2"
- 217-0017
10"×8"×2"
- 217-0018
12"×8"×2½"
- 217-0019
12"×10"×2½"
- 217-0020
14"×10"×2½"
- 217-0021
14"×12"×2½"



217-0022
8"×3"×1½"
Instruments Box

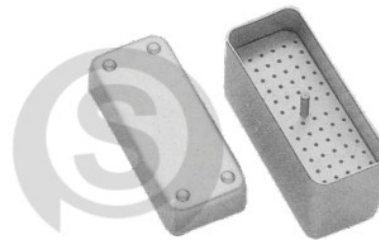

217-0023
Endodontic box

- 217-0024
10"×6"×2"
- 217-0025
12"×8"×2½"
- 217-0026
16"×12"×4"

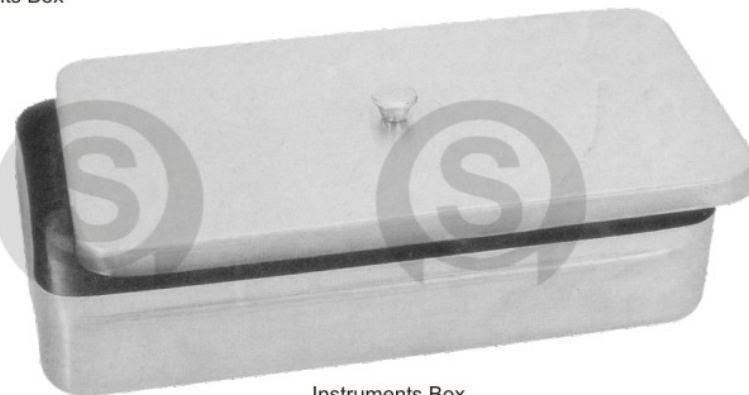

Instruments Box



●●● **HOLLOW WARE ITEMS**

	Ø	Depth
217-0027	2"	2"
217-0028	4"	2"
217-0029	5½"	2½"
217-0030	6"	2¾"
217-0031	7"	3½"
217-0032	8"	3½"
217-0033	10"	4"



Lotion Bowl

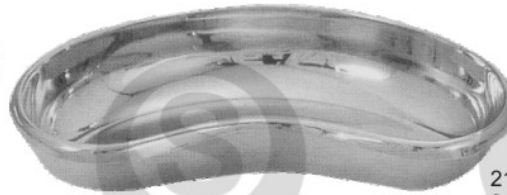

Kidney Trays

217-0034	6"
217-0035	8"
217-0036	10"
217-0037	12"



217-0038
6"×9"
Sterilizing Drum
217-0039
8" × 12"



217-0040
10" × 10"
Sterilizing Drum



217-0041
Cotton Holder



217-0042
80 × 35 mm
Medicine Cup
217-0043
125 × 60 mm

217-0046	25 × 80 mm
217-0047	30 × 100 mm
217-0048	75 × 173 mm
217-0049	100 × 200 mm



217-0044
Spirit Lamp



217-0045
Spirit Lamp



Forcep Jar



217-0050
5cmx15cm
Forcep Jar
217-0051
5cmx10cm

RUBBER DAM CLAMPS ●●●

Molar Clamps Winged



218-0001
Fig. 30



218-0002
Fig. 31



218-0003
Fig. 51



218-0004
Fig. 138



218-0005
Fig. 139



218-0006
Fig. 15



218-0007
Fig. 18



218-0008
Fig. 24



218-0009
Fig. 25



218-0010
Fig. 26



218-0011
Fig. 28

Bicuspid Clamps Winged



218-0012
Fig. 206



218-0013
Fig. 207



218-0014
Fig. 208



218-0015
Fig. 209



218-0016
Fig. 22



218-0017
Fig. 27



218-0018
Fig. 29

Molar Clamps Winged



218-0019
Fig. 26A



218-0020
Fig. 28A



218-0021
Fig. 30A



218-0022
Fig. 31A



218-0023
Fig. 51A



218-0024
Fig. 27



218-0025
Fig. 29



218-0026
Fig. 60

Molar Clamps Winged



218-0027
Fig. 200



218-0028
Fig. 201



218-0029
Fig. 202



218-0030
Fig. 203



218-0031
Fig. 204



218-0032
Fig. 205

Labial Clamps Winged



218-0033
Fig. 210



218-0034
Fig. 211



218-0035
Fig. 212



●●● ARTICULATOR



219-0001



219-0002



219-0003



219-0004



219-0005



219-0006

IMPRESSION TRAYS SETS ●●●

220-0001



220-0002

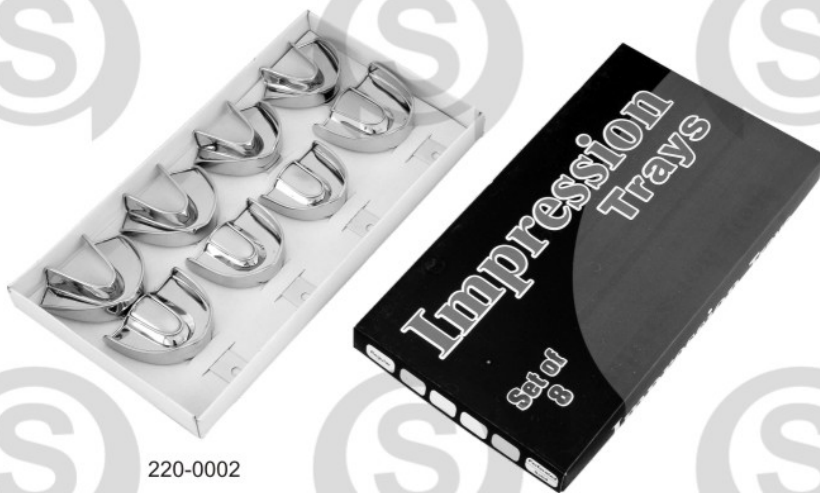

220-0003





●●● IMPRESSION TRAYS SET



220-0004



220-0005

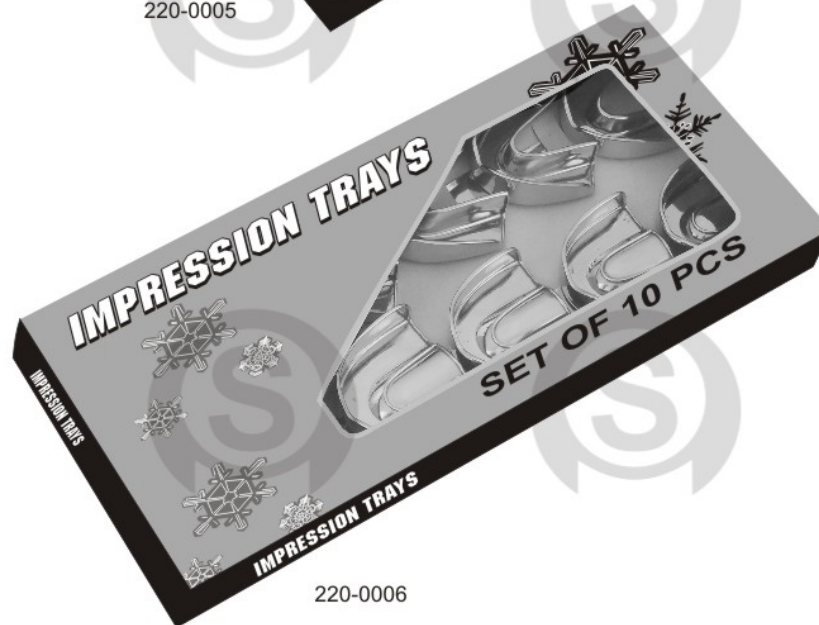

220-0006

INSTRUMENTS PACKINGS ●●●



220-0007



220-0008



220-0009



220-0010



220-0011



220-0012



220-0013



220-0014



220-0015



●●● INSTRUMENTS PACKINGS



220-0016



220-0017

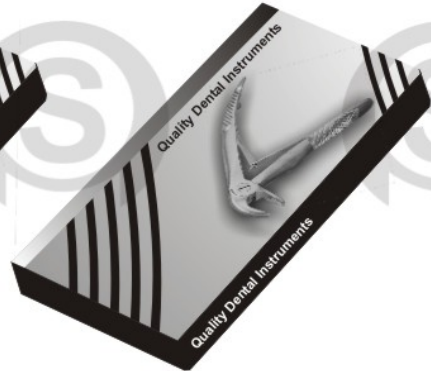

220-0018



220-0019



220-0020



220-0021



220-0022



220-0023

ASTRO MEDICAL INSTRUMENTS



A

Aspirating Syringe	95
Arruga Needle Holder	48
Apexo Root Elevator	21,22,23
Angle Pliers	30
Amalgam Carriers	94
Amalgam Well	94
Alm Retractors	53
Adson Forceps	59
Aderer Pliers	28,31,32
Adams Pliers	31,35
Arch Forming Plier	32,34
Angle Bending Pliers	33
Arch Torquing & Bending Pliers	37
Arch Turret	100

B

Bone Rongeurs	20
Bone Files	79,80
Bone Curettes	81
Boley Gauge	98
Bein Elevator	21,26
Bending plier for lingual cleat	32
Bracket Removing Pliers	33,37
Band Removing Pliers	34,37
Bending Pliers	30,32,35
Barry Elevators	27
Band Pusher	38
Bracket Tweezer	39

C

Cryer Elevators	24,26
Crown Scissors	98
Crown Removers	99
Crane-kplane	60
Coupland Elevators	25
Cotton & Dressing Pliers	60
Columbia Curettes	83
Chisels	57
Chip Blower	96
Cheatle Forceps	49
Cement Spatulas	88
Castroviejo Scissors	42
Castroviejo Needle Holders	48
Carvers	72,73
Cartridge Syringe	95
Curtis Elevators	22
Crown Spreader	98
Cogswell Elevators	23
Crile Forceps	45
Cotton Holder	110

D

Dressing Forceps	46
Distal Cutter	37

E

Extracting Forceps (English Pattern)	1,2,3,4,5,6,7,8,9,10,11,12,13
Extracting Forceps (American Pattern)	14,15,16,17,18,19
Explorers	64,65,66
Excavators	75,76,77
Endodontic Box	109

F

Farabeuf Retractor	52
Flohr Elevator	21,26
Flagg Forceps	60
Filling Instruments	68,69,70,71
Film Holder	96
Forcep Jar	110
Flat Pliers	29,33,34

G

Gum Scissors	40,41
Goldman-Fox Scissors	40,41
Goldman-Fox Scalars	82,85
Goldman-Fox Explorers	66
Graefe Retractor	50
Gracey Curettes	84
Gillies Retractor	50
Gordon - Contouring Plier	35

H

How Pliers	29,35
Hollen Back	70,72
Hollow Handle Scaler	74
Heidbrink Elevators	23,27
Handle	63
Handles For Mouth Mirror	61
Hard Wire Cutter	32,37

I

Ivory Separator	97
Iris Scissors	40
Intraligamentary Syringe	95
Instruments Trays	109
Impression Trays	101,102,103,104,105,106,107
Instruments Box	109

J

Jaquette Curettes	86
Jarabak Pliers	30

K

Kelly Scissors	41
Kidney Trays	110

L

Lucas Curettes	81
Locklin Scissors	41
Lwanson Gauge	98
Lotion Bowl	110
Ligature Pin Cutter	37

M

Mouth Mirror	61
Mosquito Forceps	39,44
Metzenbaum Scissors	43
Meriam Forceps	60
Mc Call Curettes	85
Mayo. Scissors	43
Mayo-Hegar Needle Holder	47
Matrix Retainers	97
Mathieu Needle Holders	48
Mathieu Pliers	39
Miller	100
Mixer Forceps	45
Medicine Cup	110

N

Neumann Scissors	42
Needle Holders	47,48
Napkin Holders	96
Nance Pliers	28
Nance Closing Loop Pliers	33

O

Orthodontic Instruments	38,39
-------------------------	-------

P

Plaster Cutting Pliers	100
Perry Forceps	60
Periodontia Probes	67
Periodontia Inst.	78,82,83,86,87
Peeso Pliers	30
Pean Forceps	44
Preparation Instruments	74

R

Rubber Dam Punch	58
Rubber Dam Frame	58
Rubber Dam Clamps	58
Rubber Dam Clamps Retractors	50,51,52,53
Raspatories	56

S

Sterilizing Drum	110
Splinter Forceps	19
Spirit Lamp	110
Spencers Scissors	42
Spatulas For Plasters	93
Semken-Taylor Forceps	59
Seldin Elevators	21,22,23
Scaler Sterilizing Tray	108
Skin Hook	50
Separating Pliers	38
Stout Elevators	22
Scalpel Handles	62

T

Tweed Pliers	31
Towel Clamps	49
Tofflemire	97
Tissue Pliers	59

U

Universal Pliers	28
Universal Facebow Pliers	36
Universal Scissors	98

V

Vernier Gauge Caliper	100
-----------------------	-----

W

Woodson	72
Wire Bending Pliers	31
Williger Elevators	54,55
Westcott Scissors	42
Wax Knife	92
Wax Carver	89,90,91
Water Syringe	96
Warwick James Elevator	27
Ward Carver	72
Waldsachs Pliers	28
Winter Elevators	27
Weingart Pliers	36

Y

Young Pliers	31
--------------	----